

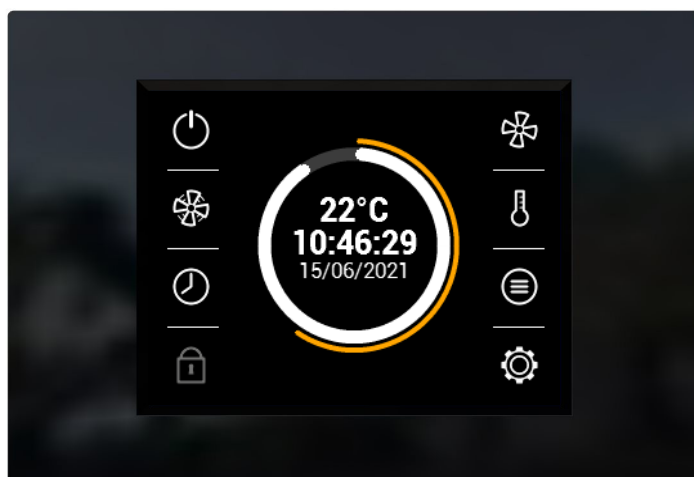

PARTNER  
IN VENTILATION  
2VV.CZ

EN

# AirGENIO<sup>2VW</sup> Superior



OPERATION AND HANDLING

EAC

CE



# CONTROL

## INITIAL COMMISSIONING

- After connecting the unit , the display lights up and the data is loaded. Once it has fully loaded, the unit is ready for start-up.
- The remote control has a touch-screen – the unit is controlled touching the symbols on the screen.

### Start-up:

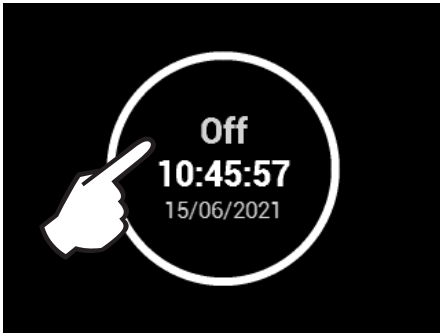

The unit is launched by pushing the red circle symbol



## INFORMATION ICONS



1. Turn the unit ON/OFF
2. BOOST mode activation
3. Unit's time switch
4. Password lock
5. Ventilation mode settings
6. Required temperature settings
7. Detailed information of ventilation status
8. Settings
9. Display of current temperature, ventilation rate, CO2 concentration, ventilation mode and date

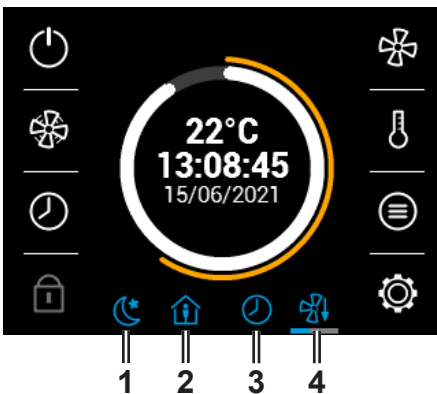

1. Night cooling
2. Occupancy mode active
3. Time mode active
4. Heater cooling in progress

## BOOST MODE

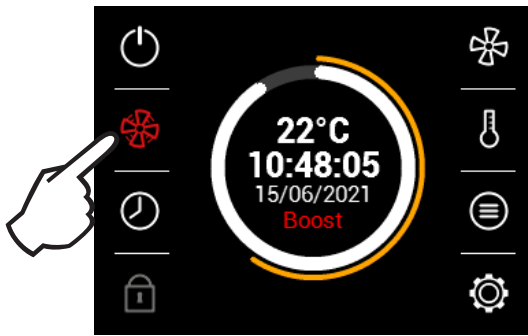

The BOOST mode is activated by touching symbol  
BOOST regime is displayed in ventilation mode area

## INFORMATION ON THE VENTILATION STATUS

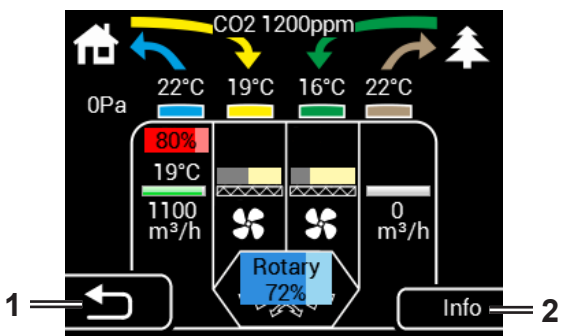

This screen shows the status of the unit and the values of the sensors:

- Current air flow of both fans
- Inlet and exhaust air temperature
- Performance of the electric preheating and reheating
- Value of the connected air quality sensor

1. Back
2. Information about unit type

## UNIT SETTINGS

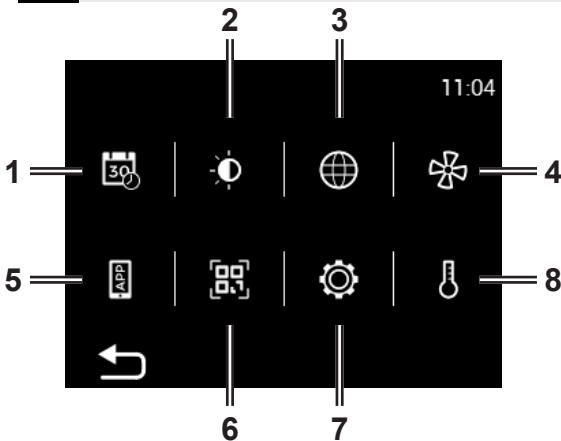

1. Date and time
2. Display settings
3. Language settings
4. Ventilation level settings
5. AirGENIO application
6. QR code with contact details and technical sheet download link
7. Unit's service setting
8. Required temperature settings

## VENTILATION LEVEL SETTINGS

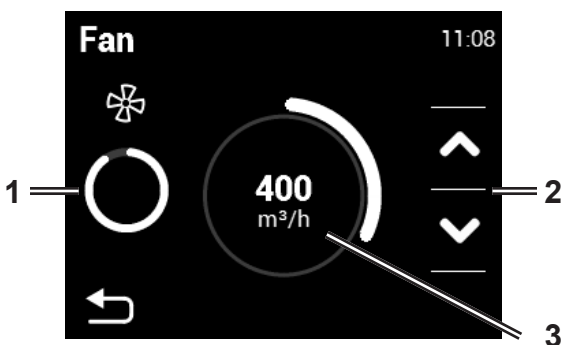

1. Display of current airflow
2. Reducing or increasing unit airflow (min 20% - max 100% in 10% increments)
3. Display of required airflow

**REQUIRED TEMPERATURE SETTINGS**

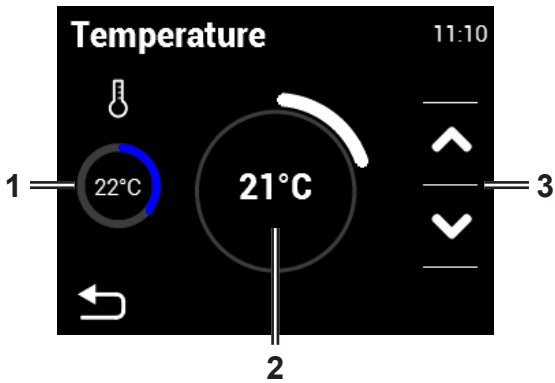

1. Display of current temperature (on selected sensor)
2. Display of required temperature
3. Reducing or increasing required temperature in the range from +15°C to +45°C

**UNIT'S TIME SWITCH**

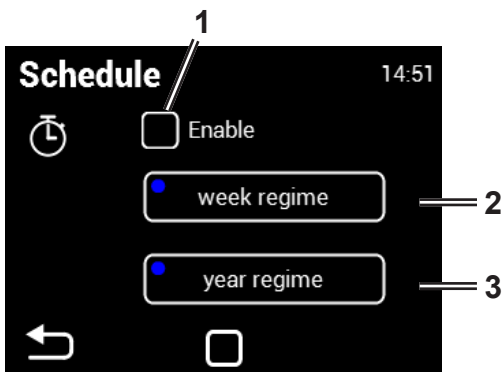

1. Activation / deactivation of time switch
2. Week regime
3. Year regime

**Week mode**

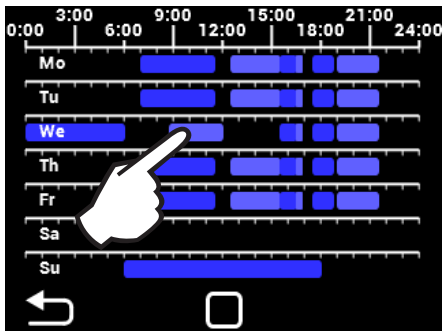

Touch a day to set ventilation modes

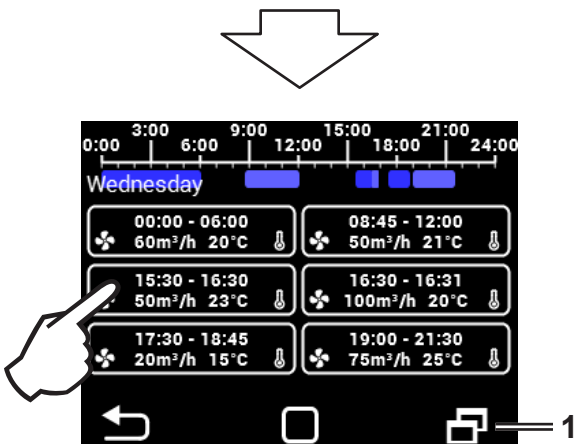

Touch to set individual intervals of ventilation (time ON/OFF, vent. mode, vent. level, temperature)

1. Touch for copying time interval

## Year mode

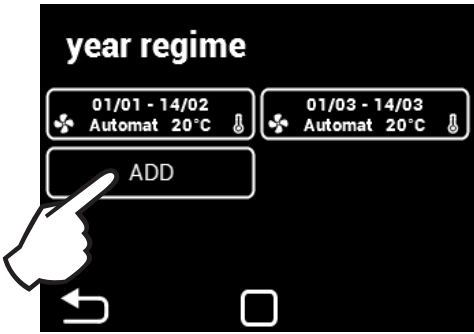

Add a time mode

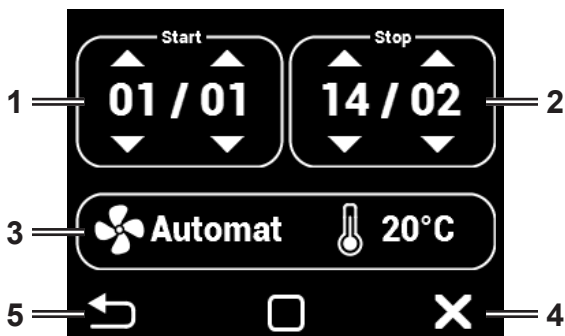

In manual mode it is possible to set the desired temperature and fan power.  
In automatic mode only the desired temperature may be set. Fan power is driven using AQS.

1. Beginning of time interval (Day/Month)
2. End of time interval (Day/Month)
3. Values setting
4. Delete time interval
5. Back

• When the time interval ends, the unit goes into stand-by mode.

## LANGUAGE SETTINGS

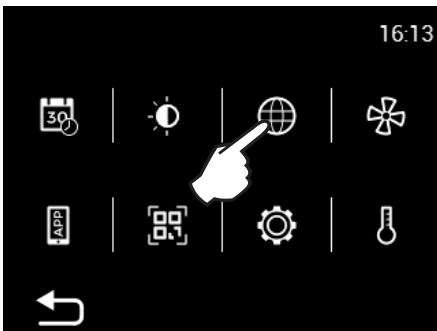

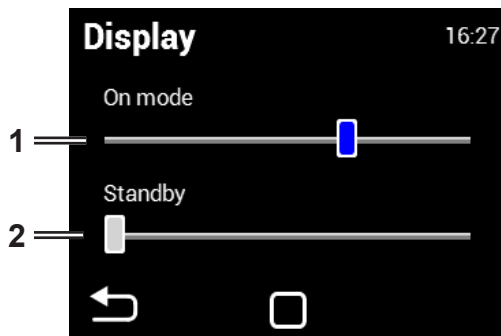
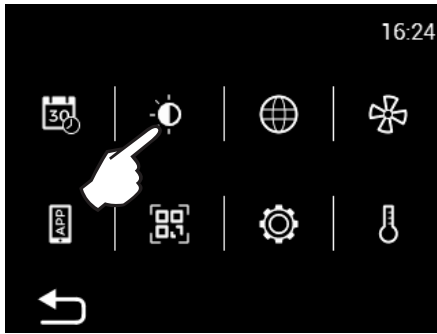
**DISPLAY SETTINGS**

1. Display brightness in active mode
2. Display brightness in Standby mode

**APP** AirGENIO APP



1. QR code for downloading the AirGENIO application for smart devices
2. Pairing mobile device with unit using QR code

The IP address and PIN of the unit can be entered manually or by using a QR code for quick pairing of the unit.

Pairing smart device with the unit using QR code



Press Google Play icon or App Store icon depending on your device type to get the app download or find it manually in the store.

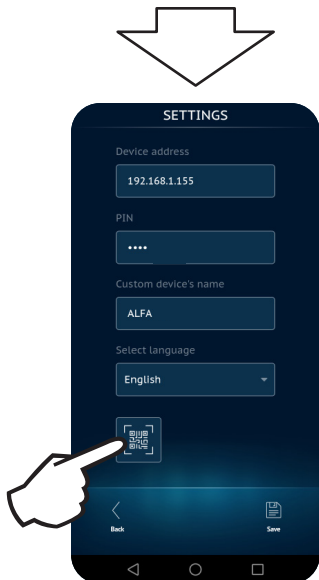

After scanning QR code from the controller press "Save" for saving the unit to the app.



Smart device manual pairing with the unit

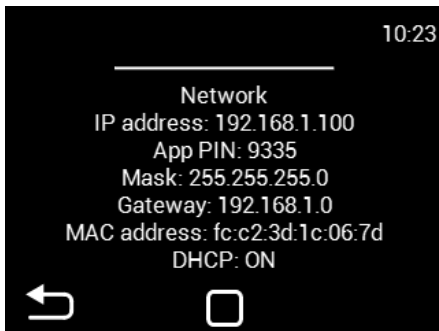
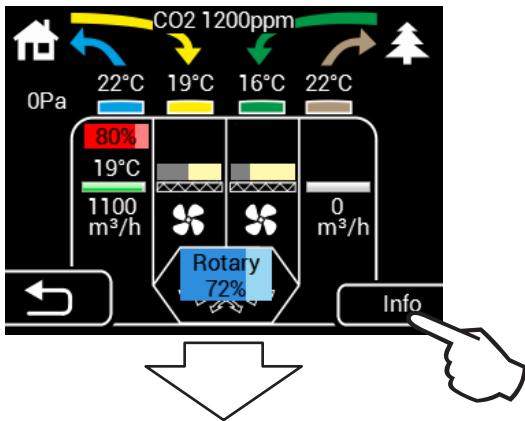
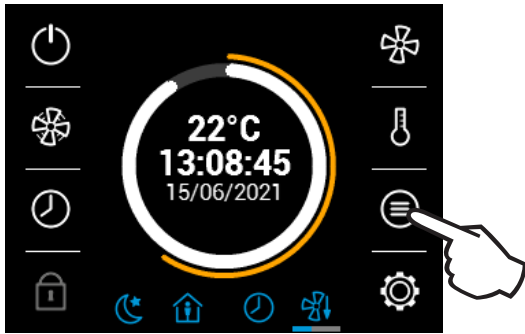

Scroll down to the Network section

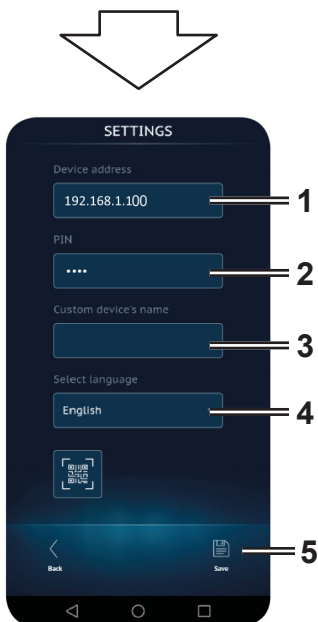

1. Enter the IP address from controller
2. Enter the PIN from the controller
3. Name the unit
4. Select language
5. After entering all the information from the controller press "Save" for saving the unit to the app.

 **TIME AND DATE SETTINGS**

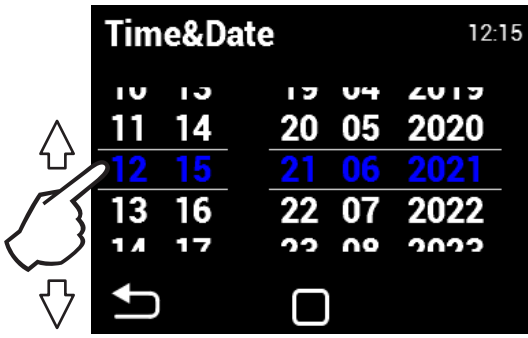

1. Scroll up and down on the numbers to set the date and time

 **SERVICE MENU**

- Use code **1616** to access the service MENU
- This MENU is intended primarily for service technicians or users who have experience with HVAC units. Changes in this MENU can lead to improper operation of the unit. If you are uncertain, first contact your supplier for more information.

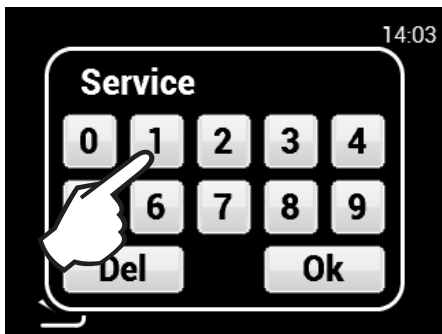

**1616**

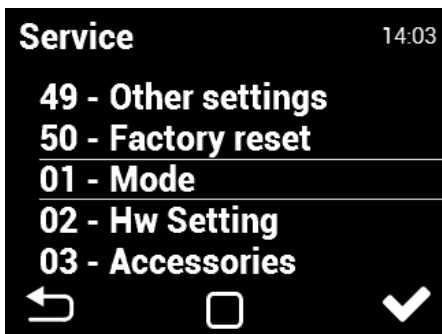

Scroll up/down to select menu then tap on selected menu

01 Mode

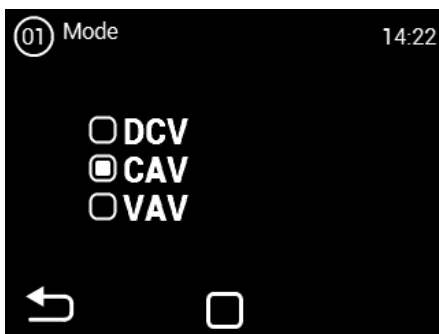
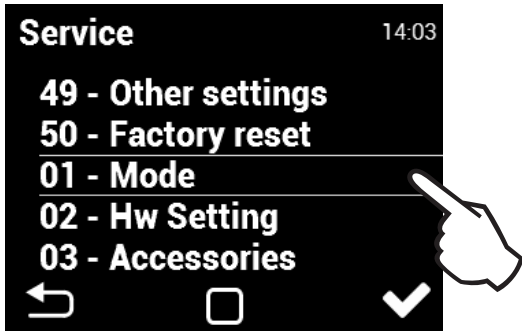

Select required ventilation mode

**DCV** - Ventilation according to the requirements of the air quality sensor (AQS)

- Unit ventilates at the air quality sensor (AQS) requirements, e.g. CO2, RH (sensor control signal must range from 0-10V).

**CAV** - manual ventilation mode

- Unit ventilates at the selected power independent of the AQS

**VAV** - variable air volume - constant pressure in the supply duct

- The unit changes the flow rate to the total opening or closing of VAV dampers in the supply ducts (done in the case of ventilation multiple zones with individual requirements for ventilation intensity - each zone is equipped with inlet control VAV flap = separate independent control circuit)

The Software reset (menu 48) must be performed to save the changes

02 HW Settings

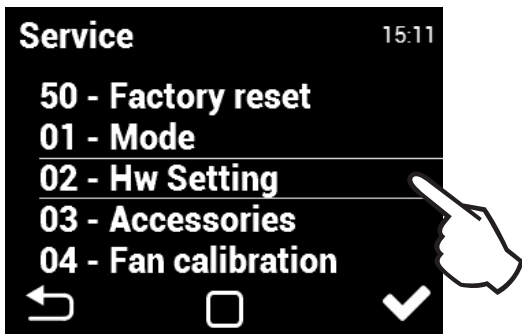

In this menu you can set the logic of using the RUN contact and the logic of antifreeze protection

1. RUN contact settings

This menu lets you select the logic using with the RUN output. Input (7-8) - The logic of the connected RUN contact can be set as follows: as N. close (normally closed) or N. Open (normally open)

2. Setting the logics of the behaviour of the exhaust fan during active antifreeze protection

**03 Accessories**

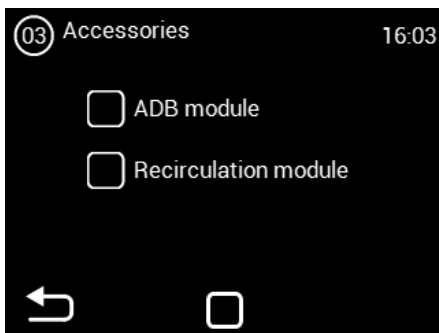
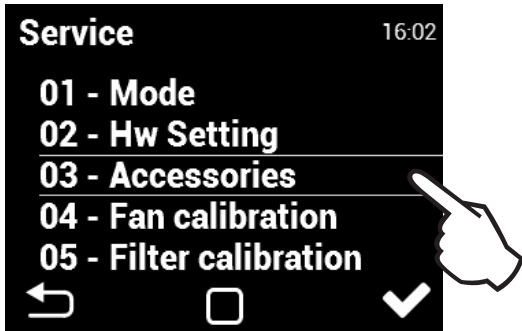

Select optional accessories

**The Software reset (menu 48) must be performed to save the changes**

**04 Fan calibration**

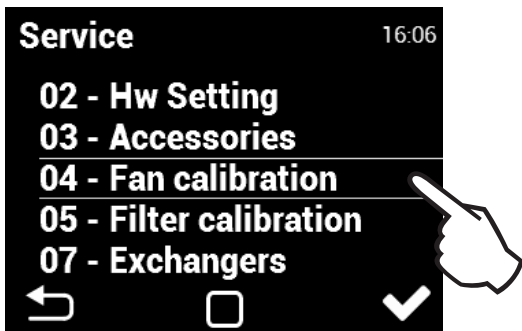

The calibration takes several minutes. Do not disconnect the unit, wait until it's completed. During the calibration the unit determines the maximum pressure loss, when the fan runs at full rate.

**READ CAREFULLY!** The unit will not work properly if, during calibration, the distribution network is not complete, the flaps or valves are not closed, etc.

**05 Filter calibration**

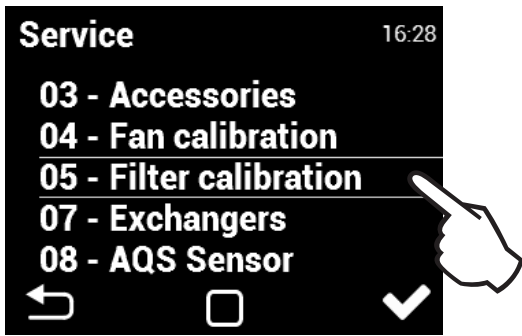

Filter calibration has to be carried out during the first commissioning and after a filter class change.



**07 Exchangers**

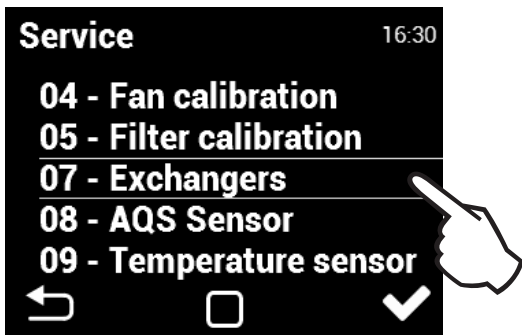

This menu serves to set the second (additional) preheater or post heater.

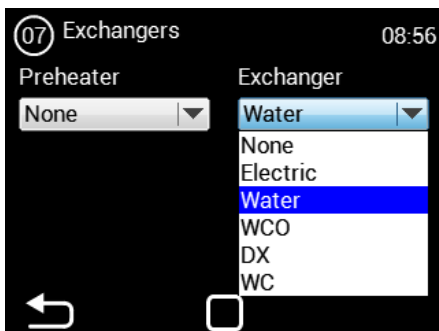

**Preheating: (not for HR85)**  
 None  
 Electric  
 Water

**Postheater:**  
 None  
 Electric  
 Water  
 WCO  
 DX

The Software reset (menu 48) must be performed to save the changes

08 AQS Sensor

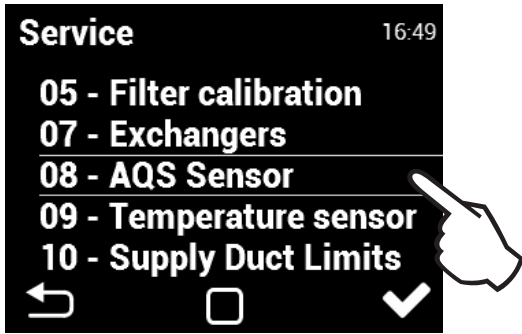

AQS = Air Quality Sensor

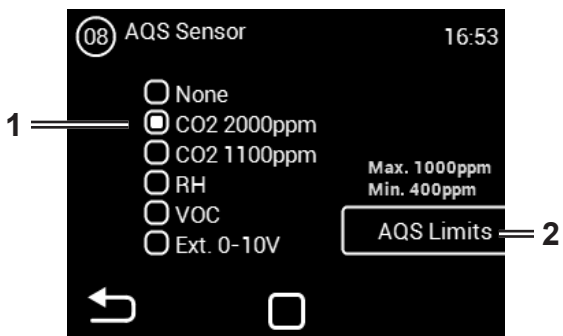

1. Select air quality sensor
2. Set the limit of the selected air quality sensor
3. Activation of the mode in which the unit performs test air intake if AQS channel is used
4. Required limits setting

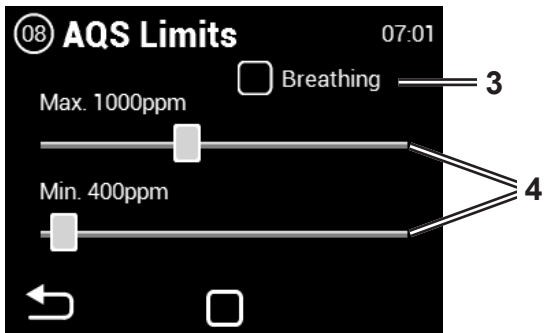

**BREATHING**

with the breathing mode enabled, the unit shuts down after reaching the minimum concentration and then inhales every 15 minutes for 2 minutes at minimum fan power. If the concentration exceeds the maximum value, ventilation is reactivated. If the max. Limit is not exceeded, the unit switches off again until the next inhalation.

**The Software reset (menu 48) must be performed to save the changes**

## 09 Temperature sensor

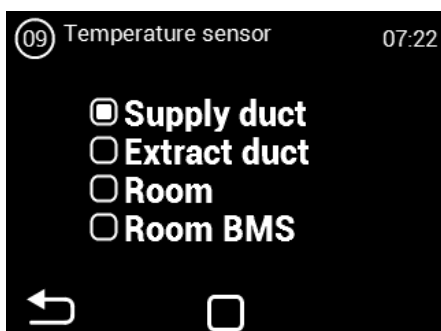
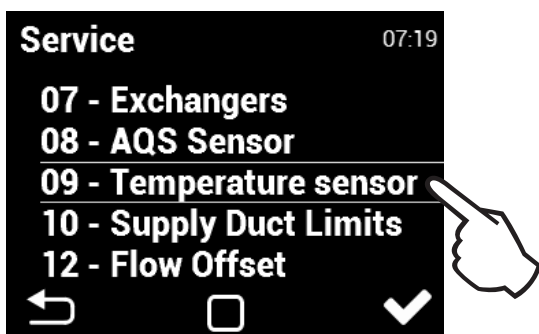

A temperature sensor can be selected to control the air temperature. The values from the selected sensor will be used for temperature control and will be displayed on the main controller screen.

**The Software reset (menu 48) must be performed to save the changes**

**Supply duct:**

The unit will be controlled by the supply air temperature sensor to the object. Suitable for installations where the same supply air temperature is required to the rooms and in individual rooms is further adjusted as required. There is no local overheating. Suitable for multi-zone ventilation. The unit will respond quickly to temperature changes at this setting. ATTENTION: With this setting, the MAX and MIN channel limit values cannot be defined. The maximum limit in the channel is the desired temperature. The minimum temperature is set to 15 ° C. (for its adjustment it is possible to go to the sensor of the outlet channel, adjust the limit and change the sensor to the supply - the MIN value will be respected according to the settings).

**Extract duct:**

The unit will be controlled by the extract air temperature sensor from the object. Suitable for installations where it is necessary to monitor the average exhaust air temperature and adjust the supply air temperature to achieve comfort in the building. Suitable for mono-zone ventilation where supply air affects one room. The unit will respond more slowly to the temperature change at this setting. The supply air temperature is between the minimum and maximum supply air temperature.

**Room:**

The unit will follow the temperature sensor installed in the room. Suitable for installations where it is necessary to monitor the local room temperature and adjust the supply air temperature to achieve room comfort. Suitable for monozone ventilation, where the supply air affects one space. The supply air temperature is between the minimum and maximum supply air temperature. According to the setting in the menu 10 - SUPPLY DUCT LIMITS.

**Room BMS:**

Temperature information provided by the building management system

**10 Supply Duct Limits**

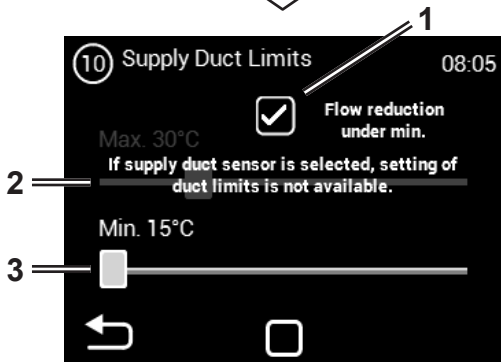
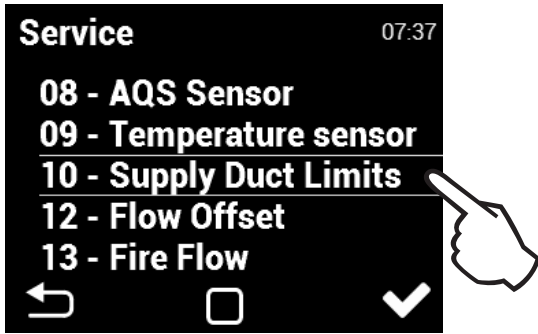

1. Enable or disable the ventilation level reduction if canal minimum is not reached (enabled by default)
2. Set maximum canal temperature range of +25 °C to +45°C.
3. Set minimum canal temperature range of +15 °C to +20°C.

- Due to possible condensation on the surface of the ventilation ductwork, it is recommended to leave enabled the reduction of flow if canal minimum is not reached.
- Selecting the sensor in the supply ductwork disables the maximum temperature setting in the ductwork.

**11 Bypass Temperature**

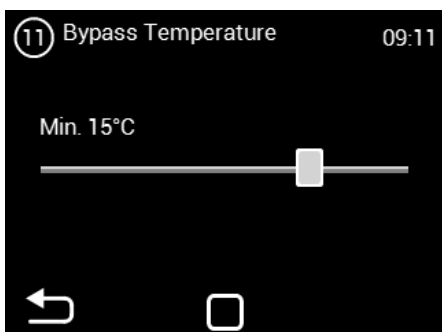
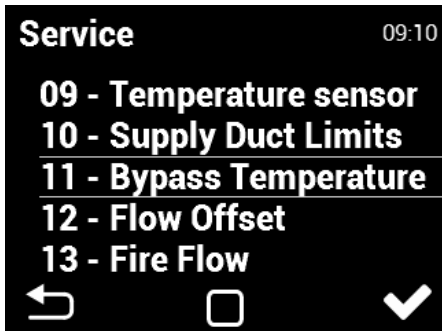

Setting of minimum outdoor temperature from which the bypass opening is allowed (range 0-20°C)

**Does not apply to units HR85**

12 Flow Offset

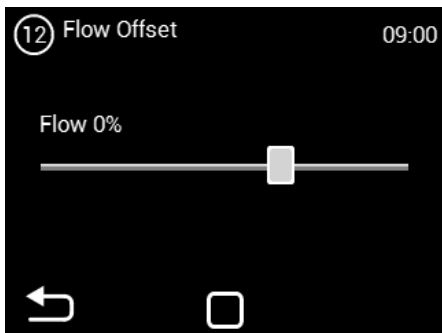
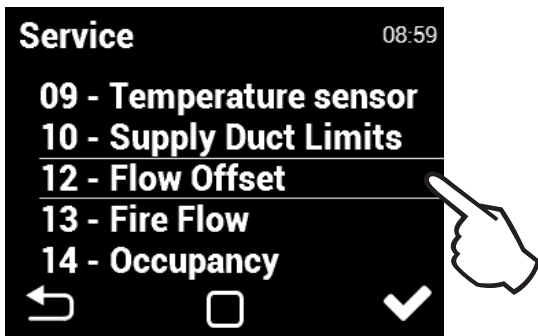

**Setting underpressure or overpressure**

0% - equal pressure, positive value - overpressure, negative value - underpressure

13 Fire Flow

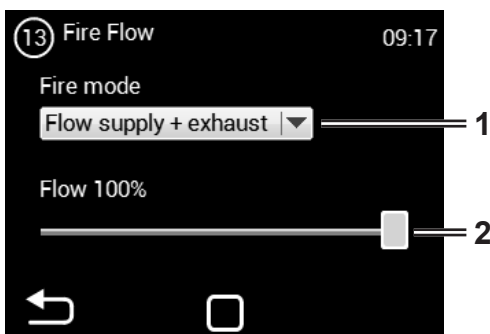
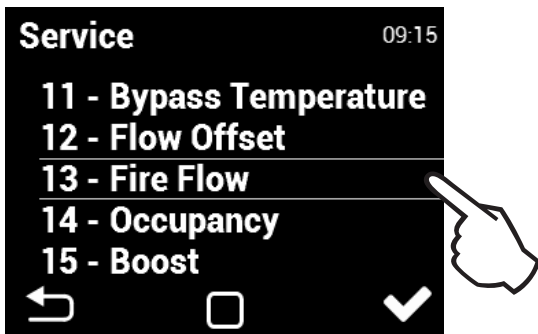

**Settings for how the unit in this mode should maintain:**

**Without flow** - both motors deactivated

**Flow intake + exhaust** - both motors activated

**Intake only flow** - only the motor for the intake branch will be activated

**Exhaust only flow** - only the motor for the exhaust branch will be activated

2. Setting the airflow when the FIRE contact opens (input terminals 15/16)

**FIRE VENTILATION input has highest priority (it deactivates all other modes, including anti-frost protection).**

14 Occupancy

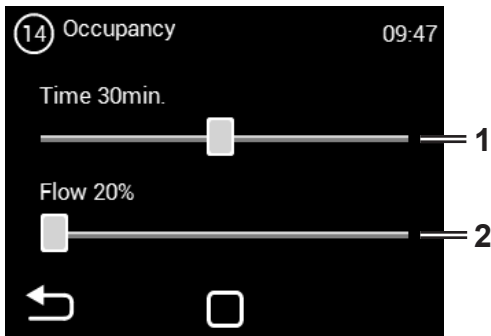
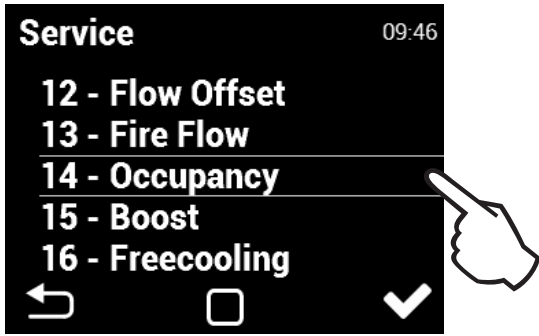

1. Setting the time interval after which the mode will be active after PIR sensor activation (input at terminals 15/16). Range 1 - 60 minutes
2. Setting the required flow range of 20% to 50%

15 Boost

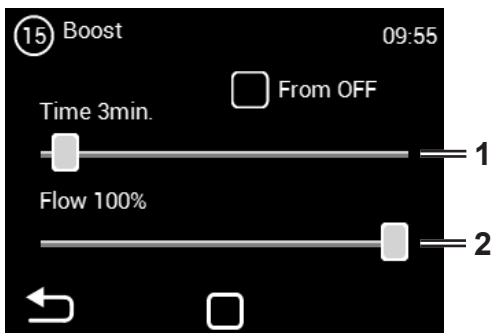
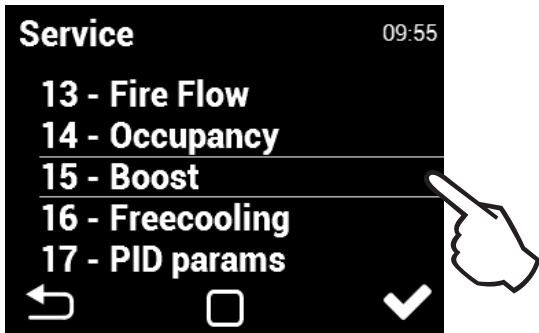

Boost can be activated with the button connected to the input 13/14, or with the Boost button (Fig. Boost) on main screen

Enabling BOOST mode activation from Standby state of the unit. Activation can be achieved solely using an external button. The unit is automatically engaged at the set time and power after activating the button.

**CAUTION: After this mode is over, the unit does not switch back into Standby mode but will remain active. The unit will work at the value set prior to its transition into Standby mode.**

1. Setting the time interval for which the mode will be active after the BOOST contact is activated
2. Setting the required airflow

16 Night ventilation

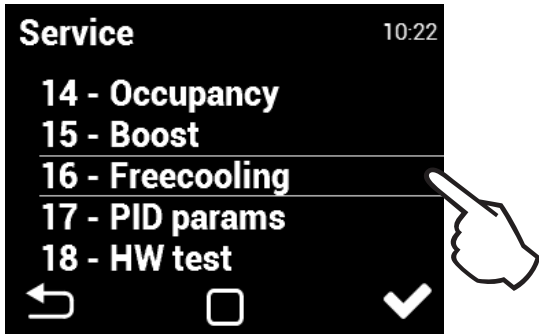

NIGHT VENTILATION is evaluated even if the unit is in Standby mode (at the selected date and time the unit activates and evaluates where night ventilation can be activated - Prefreecooling)

**NIGHT VENTILATION does not replace an air conditioning unit. The primary purpose of the unit is to ventilate, not to cool.**

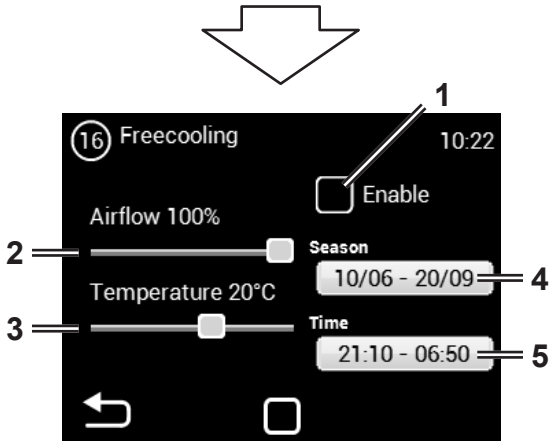

1. Enabling NIGHT VENTILATION mode
2. Setting the required flow range of 50% to 100%.
3. Setting desired temperature (measurement on Exhaust Channel sensor). Range of +12°C to +25°C.
4. Date (for evaluating the activation of NIGHT VENTILATION)
5. Setting the time (for evaluating the activation of NIGHT VENTILATION)

17 PID parameters

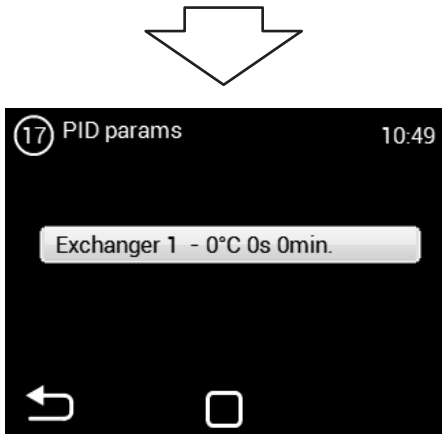
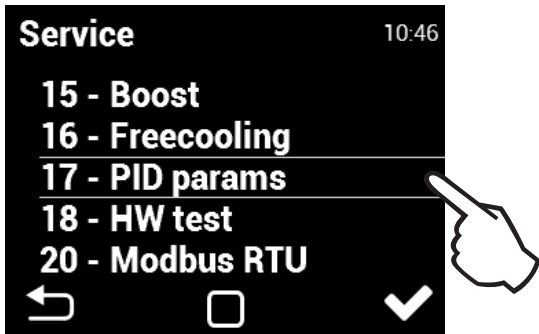

Setting the regulation characteristics If regulation is variable or inconsistent. This setting may be carried out solely following consultation with the manufacturer.

18 HW test

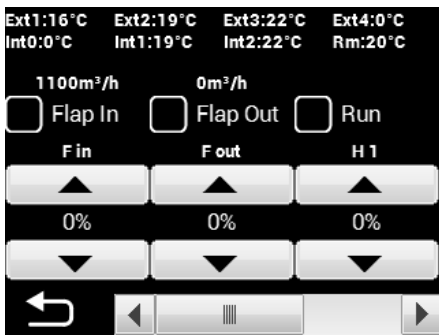
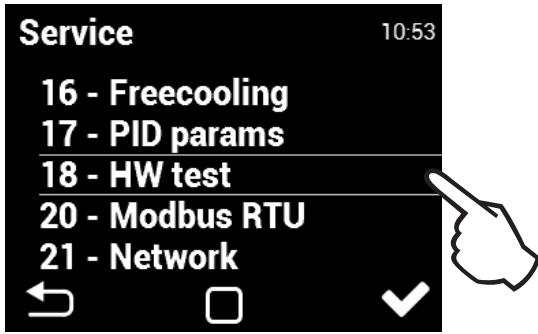

The HW TEST menu is used to test all the connected components and accessories. These parameters are not saved.

- F in** - Intake fan speed configuration
- F out** - Exhaust fan speed configuration
- Pre 1** - Electric preheating power configuration (intake fan automatically activated)
- Ext1** - Intake air temperature sensor (fresh air supply)
- Ext3** - Air intake temperature sensor (inlet to room)
- Int1** - Exhaust air temperature sensor (exhaust before core)
- Int2** - Anti-freeze sensor of the heat exchanger (exhaust behind core)

19 DX exchanger

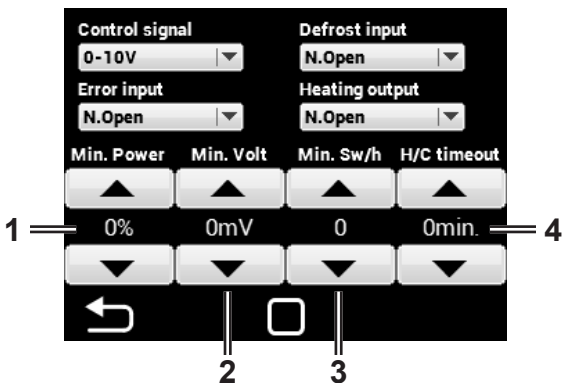
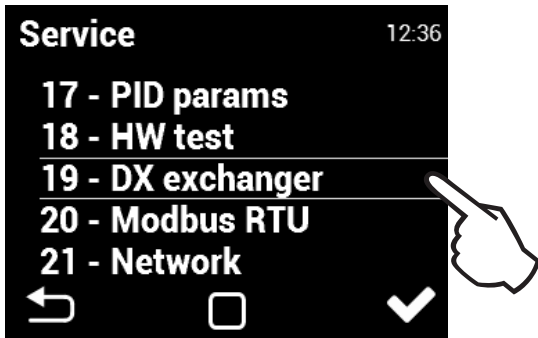

1. Min. power for switching the heat pump
2. Upper output limit 0-10V of HEATER/COOLER output for requirement state of 0% capacity of the condensing unit, default = 1V
3. Max. number of activations of the condensing unit in ON/OFF mode per hour, range 3 - 60, default = 6
4. HEAT/COOL delay in output switching, range 1 - 20 minutes, default 3 = minutes

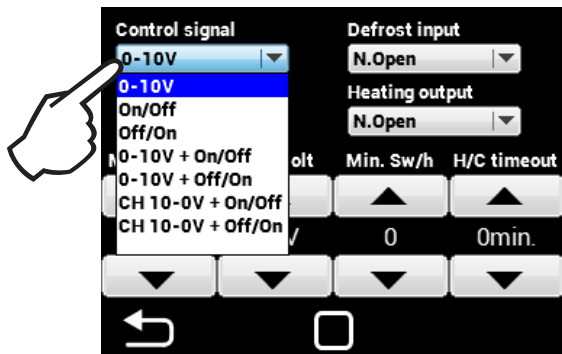

- Control signal options:**
- 0-10V** - 0-10V signal control
  - On/Off** - On/Off switching
  - Off/On** - Off/On switching
  - 0-10V + On/Off** - On/Off switching + 0-10V signal control
  - 0-10V + Off/On** - Off/On switching + 0-10V signal control
  - CH 10-0V + On/Off** - On/Off switching + 0-10V signal control cooling, heating 10-0V
  - CH 10-0V Off/On** - Off/On switching + 0-10V signal control cooling, heating 10-0V

20 Modbus RTU

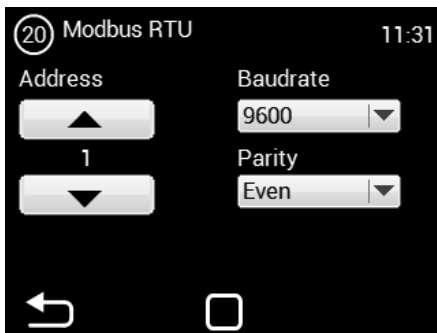
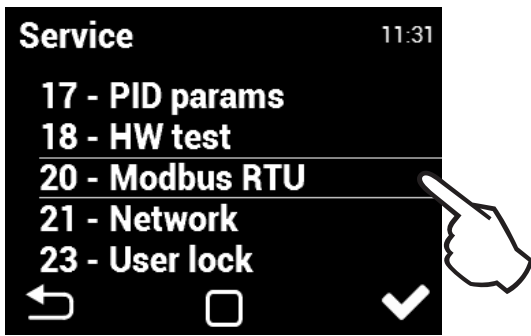

The MODBUS menu is used to set the Modbus communication.

21 Network

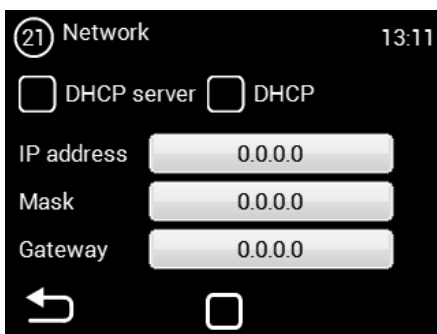
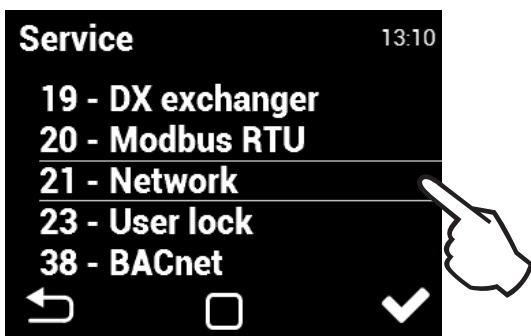

The NETWORK menu serves for setting the network communications of the unit (TCP Modbus).

**The Software reset (menu 48) must be performed to save the changes.**

23 User lock

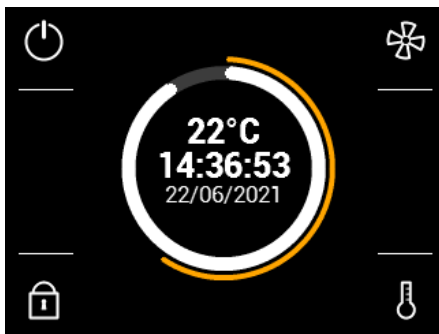
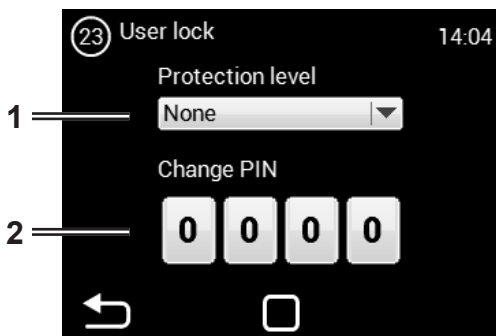
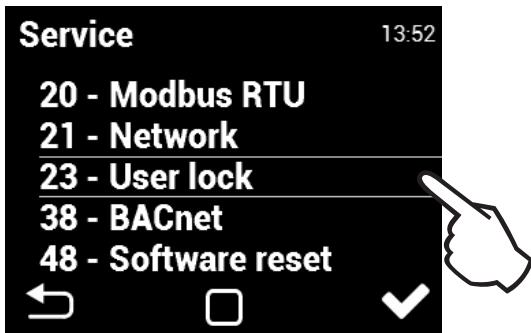

1. User security level
2. Numeric password to unlock

Several security levels can be chosen for possible password-free operation:

**Activate/Deactivate** - Enables activation and deactivation of the unit without password

**Activate/Deactivate, Temperature, Flow** - Enables activation

and deactivation of the unit, setting required temperature, and ventilation power without password

**Temperature, Flow** - Enables setting the desired temperature and ventilation power without password

**Full** - Does not enable any settings without entering password

**User mode** - Enables the unit to be operated per the following screen:

After entering the password, the unit can be fully operated and set

38 BACnet

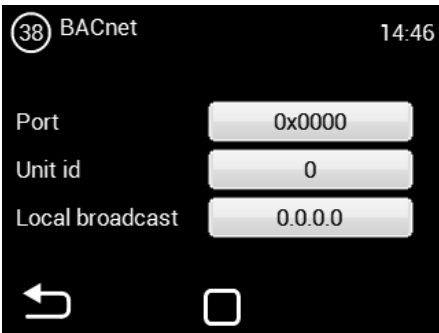
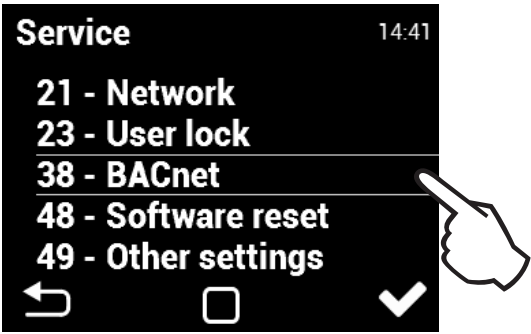

The BACnet menu is used to set the unit's network communication (ModBus TCP).

48 Software reset

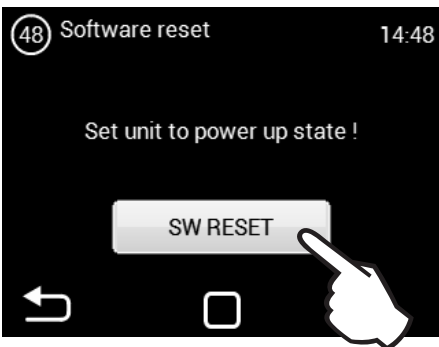
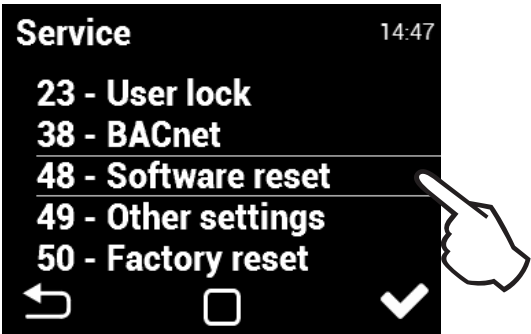

Power reset

49 Other settings

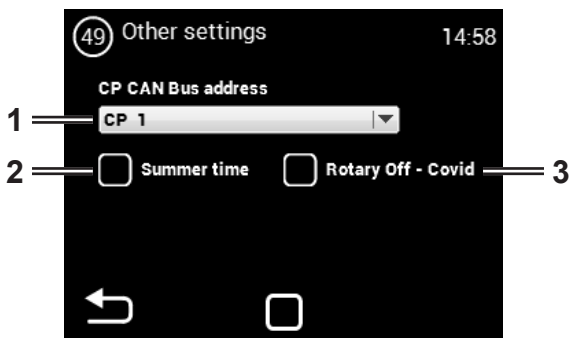
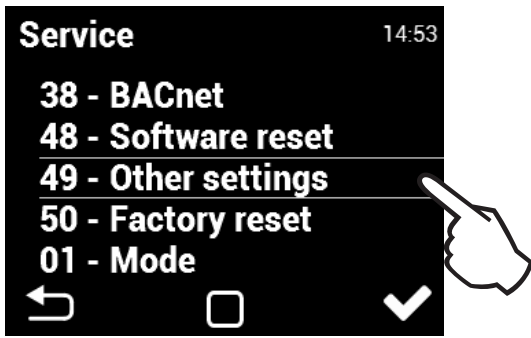

1. Controller address - only if two controllers connected. This setting is saved in each controller separately. CP1 - Address 1, CP2 - Address 2

2. Summer time enabled/disabled

3. Switch off the rotary heat exchanger (no heat recovery) - for HR85 only

50 Factory reset

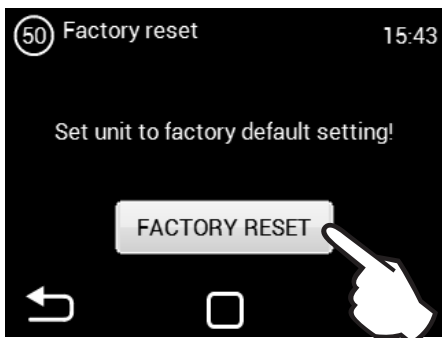
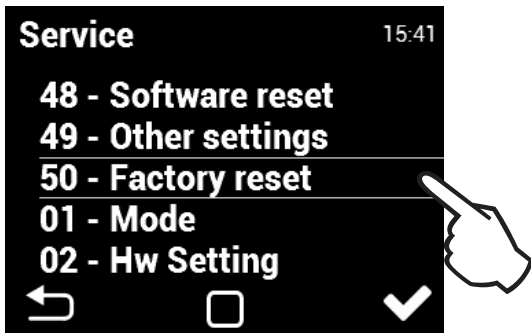

Pressing FACTORY RESET resets the unit to its factory settings

- does not change - the configuration AQS
- ventilation mode
- HW settings
- temperature settings
- Modbus settings



## MAINTENANCE



### Filter change

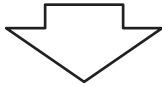
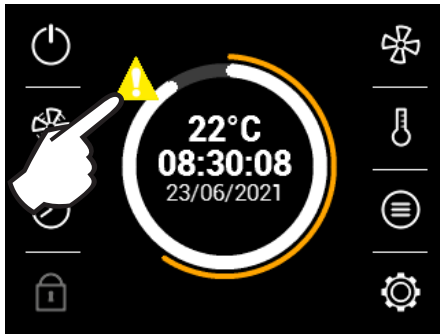

Filter clogging indicator is located on the control display panel.

The clogging of the filters is automatically assessed. The unit will automatically recognize that a new filter has been installed.

#### **ATTENTION!**

**In case that filters will not be replaced properly, functionality of the unit may be reduced the preheater can overheat and ventilator can be damaged.**

## ? TROUBLESHOOTING

The unit error is indicated with a red exclamation mark in the middle of the control display  
Pressing the exclamation mark shows the information on the error, see table below.

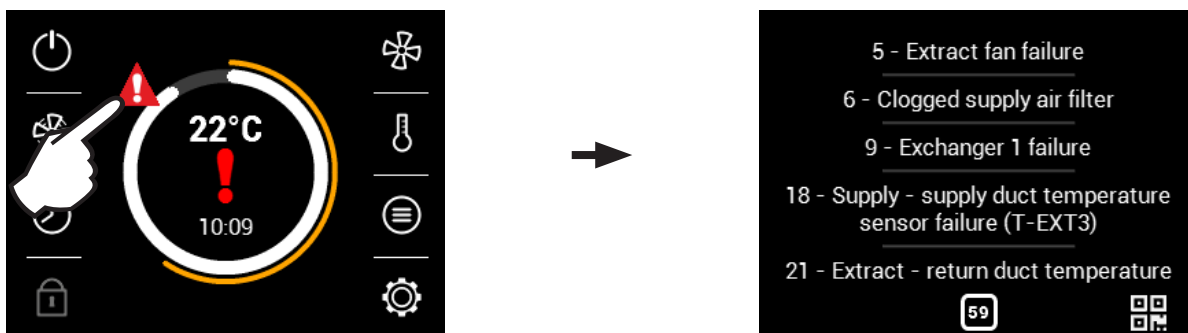

Reports on the display	Unit's behaviour	Likely problem	SOLUTION
1 – Exchanger 1 over-heated	unit is ventilating	Preheated electric exchanger or damaged sensor	Check that the air is flowing freely through the unit, that the electric exchanger cools down sufficiently, or that the safety thermostat of the el. reheating isn't damaged.
3 – Overheated preheating	unit is ventilating	Preheated electric preheater or damaged sensor	Check that the air is flowing freely through the unit, that the electric exchanger cools down sufficiently, or that the safety thermostat of the el. reheating isn't damaged.
4 – Supply fan error	Unit is not working	Overheated fan or defect on thermal contact of inlet fan	Determine the cause of the overheating: defective bearing, short-circuit...
5 – Exhaust fan error	Unit is not working	Overheated fan or defect on thermal contact of inlet fan	Determine the cause of the overheating: defective bearing, short-circuit...
6 – Inlet filter clogged	unit is ventilating	Check clogged filter	If the filter has been replaced or if it does not need to be replaced, reset the filter clogging
7 – Exhaust filter clogged	unit is ventilating	Check clogged filter	If the filter has been replaced or if it does not need to be replaced, reset the filter clogging
12 – CO2 sensor failure	unit is ventilating	Defective air quality sensor	Control the air quality sensor and its connection to the unit
16 – Inlet – External temperature sensor failure (T-EXT1)	unit is ventilating	Defective contact or sensor	Control the connection of the sensor and replace if needed (professional service)
17 – Inlet – Failure of the temperature sensor behind the exchanger (T-EXT2)	unit is ventilating	Defective contact or sensor	Control the connection of the sensor and replace if needed (professional service)
18 – Inlet – Temperature sensor failure in the supply canal (T-EXT3)	unit is ventilating	Defective contact or sensor	Control the connection of the sensor and replace if needed (professional service)
21 – Exhaust – Temperature sensor failure in the exhaust canal (T-INT1)	unit is ventilating	Defective contact or sensor	Control the connection of the sensor and replace if needed (professional service)
22 – Exhaust – Failure of the temperature sensor of the exchanger's anti-freeze protection (T-INT2)	unit is ventilating	Defective contact or sensor	Control the connection of the sensor and replace if needed (professional service)
25 – Room temperature sensor failure (T_Room)	unit is ventilating	Defective contact or sensor	Control the connection of the sensor and replace if needed
74 – Flow reduction, minimum temperature in the canal not reached	Limited operation of the unit	The minimum temperature in the canal was not reached	The temperature of the inlet and exhaust air is too low. Risk of undercooling of the building or condensation in the ventilation ductwork Possible failure of temperature sensor T-EXT3
Condensation fault	Unit is working	High level of condensate in the unit	Check if the sink is connected to the outlet of the condensate tank, the condition of the connection, and whether the sink is full of water. Check the flow of the ducts and whether the position of the unit allows runoff.
The unit ventilates insufficiently or is noisy	Unit is working	Clogged filter or ductwork.	Check the filters and whether the ductwork is not clogged

## i CONCLUSION

Once the it has been installed, read carefully the safe operation manual of the unit. That manual includes examples of possible problems and recommended solutions. In case of any requests or inquiries, contact our sales or technical department.

### CONTACT

**Address**

2VV, s.r.o.,  
Nádražní 794  
533 51 Pardubice – Rosice,  
Czech Republic

**Website:**

<http://www.2vv.cz/>

