



PARTNER  
IN VENTILATION  
2VV.CZ

EN

# *ESSENSSE NEO*

## *COMFORT* v3



**Installation and operation instructions**



## CONTROL THE DELIVERY

### PLEASE NOTE

Check the product for damages immediately after delivery. In case of damage on the packaging, contact the carrier. Claims not filed in due time will be disregarded.

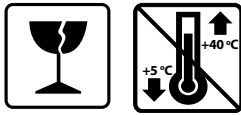
- Check that it corresponds to the type of product ordered. In case of discrepancy, do not unpack the product and contact the vendor.
- After unpacking, check that the product and all the other components are in good order. In case of doubt, contact the vendor.
- Do not install a damaged unit!
- If you will not unpack the product immediately after delivery, store it indoors, in a dry place with ambient temperatures between **+5 °C and +40 °C**.



	All the packaging material is environmentally friendly and can be reused or recycled. Contribute actively to the protection of the environment and ensure the proper disposal or recycling of the packaging materials.	
---	--	---

## PACKAGE CONTENTS

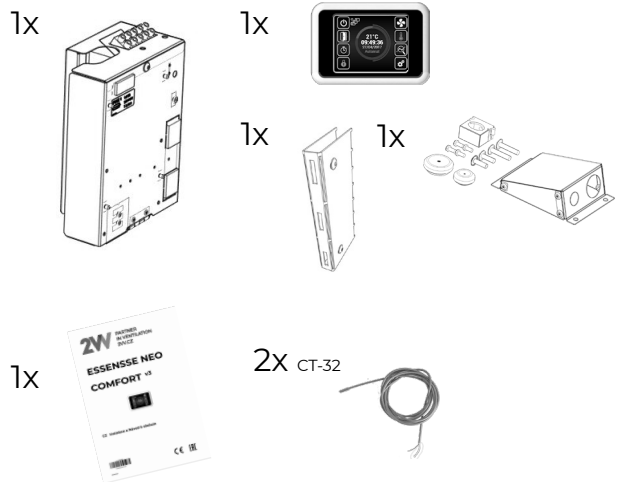

### PLEASE NOTE

- If the unit was transported in temperatures lower than 0°C, after unpacking, leave it in operational conditions for at least two hours without activating in order to compensate the inner temperature.

## 1. INSTALLATION

### 1.1 CONNECTING THE CONTROL

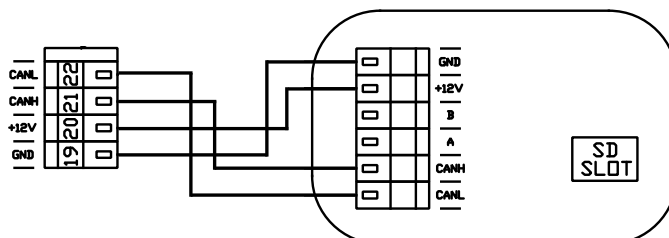
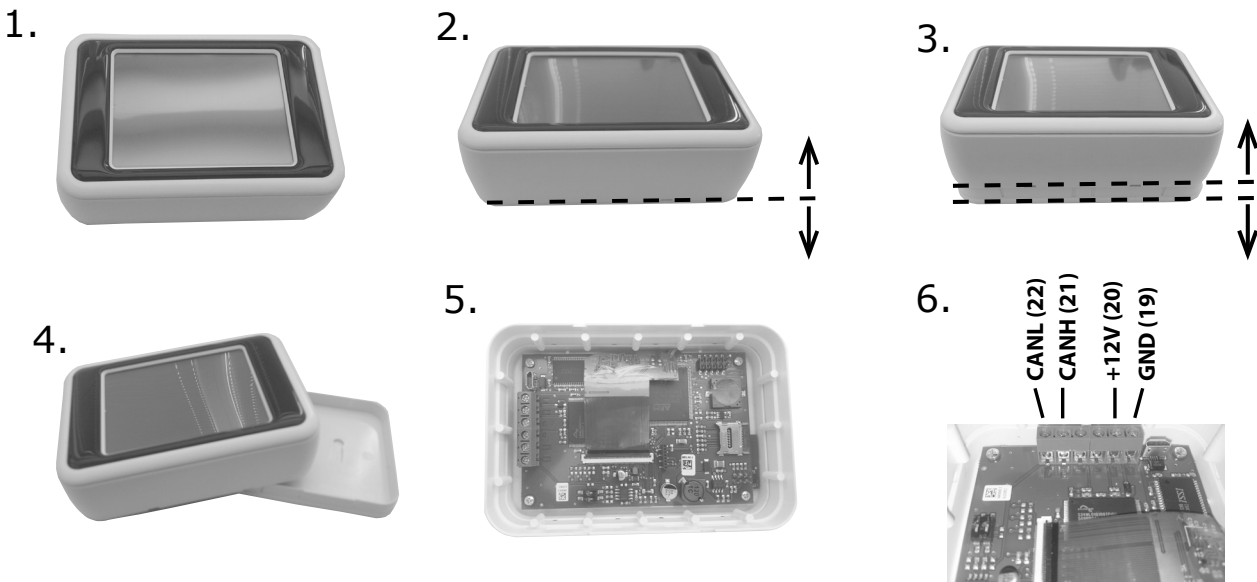

# 1. INSTALLATION

## 1.2 EXTERNAL ACCESSORIES

COMFORT MASTER  
Regulation module Master Comfort

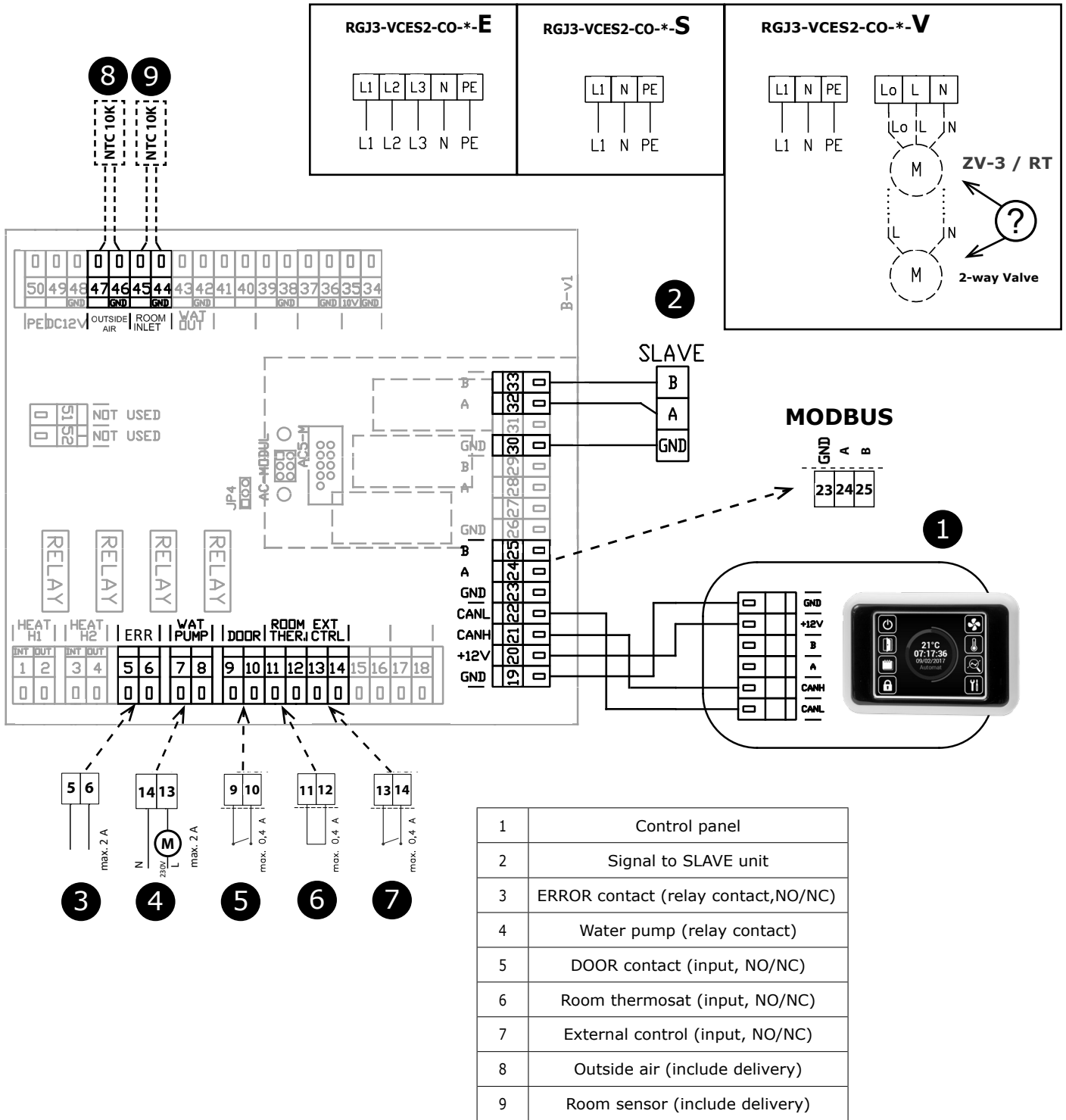

# 1. INSTALLATION

COMFORT SLAVE  
Regulation module Slave Comfort

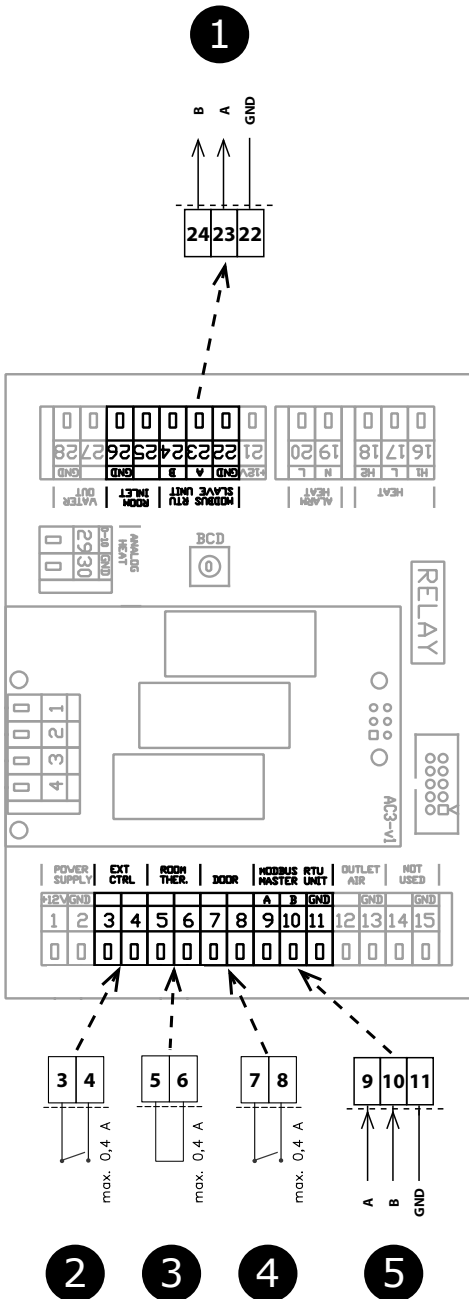
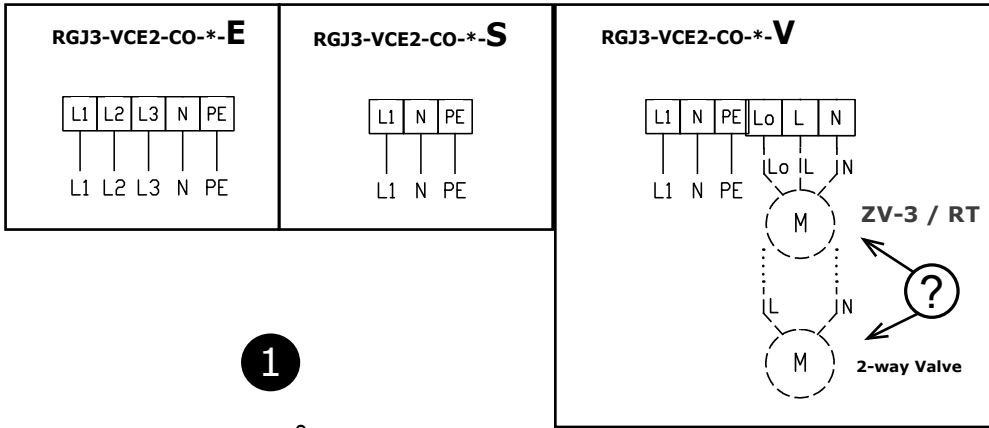

<b>1</b>	Connection for SLAVE unit
<b>2</b>	External control (input, ON/OFF)
<b>3</b>	Thermostat (input, NO/NC)
<b>4</b>	DOOR contact (input, NO/NC)
<b>5</b>	Control signal from MASTER unit

# ELECTRICAL SCHEMES CHAINING

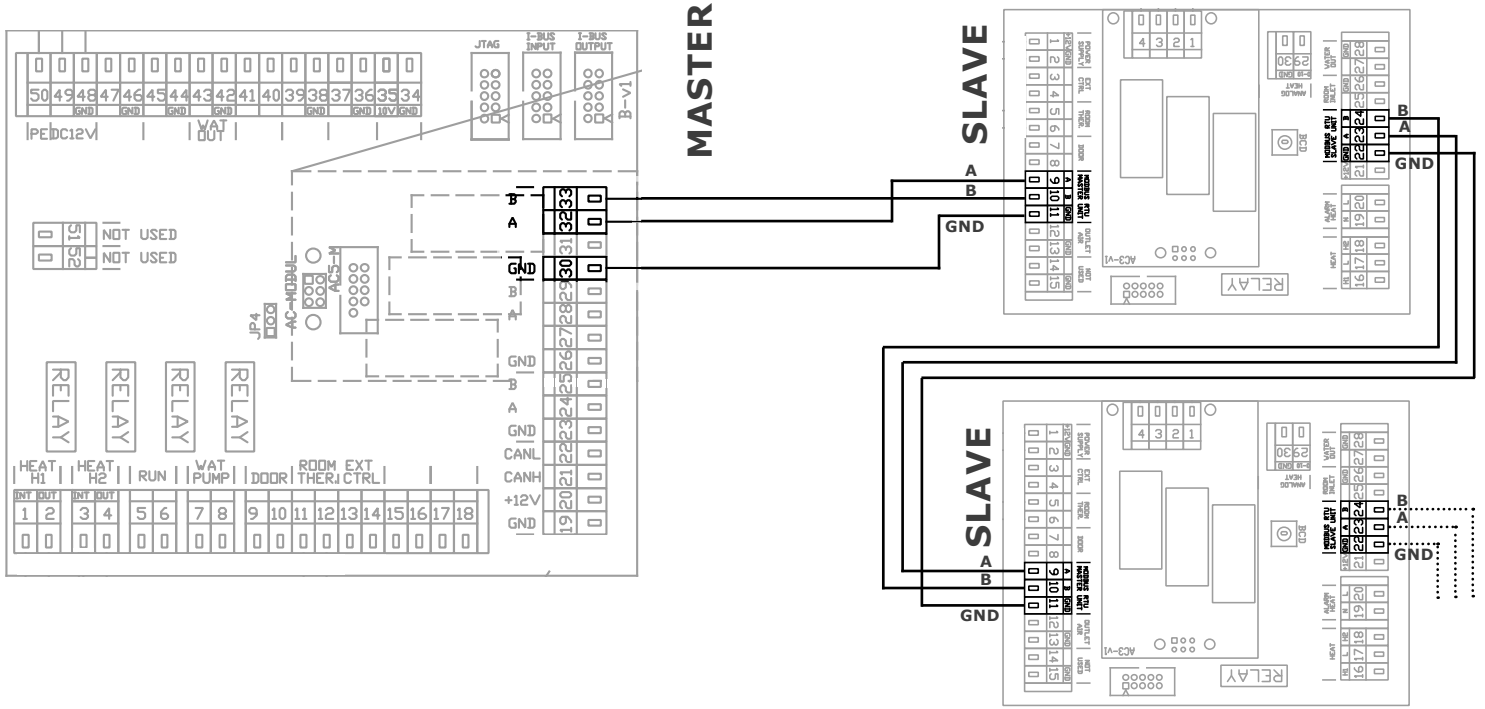
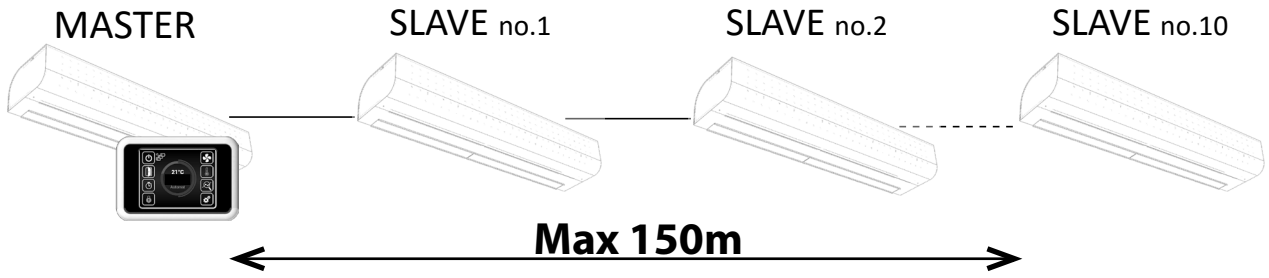

**The total bus length of all chained curtains must not exceed 150m!!!**

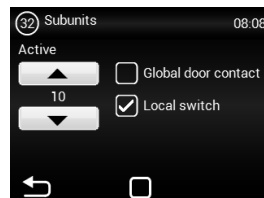
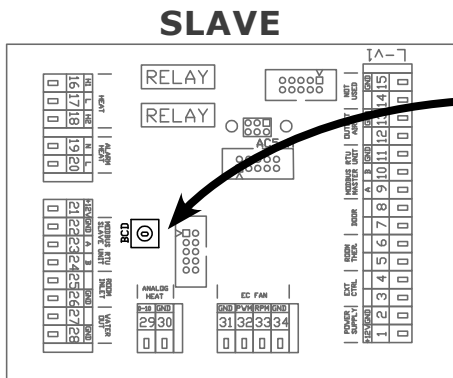

SLAVE	BCD	SLAVE	BCD
NO.1	1	NO.6	6
NO.2	2	NO.7	7
NO.3	3	NO.8	8
NO.4	4	NO.9	9
NO.5	5	NO.10	A

# 1. INSTALACE

Location of temperature sensors

Room Temperature Sensor - Accessories

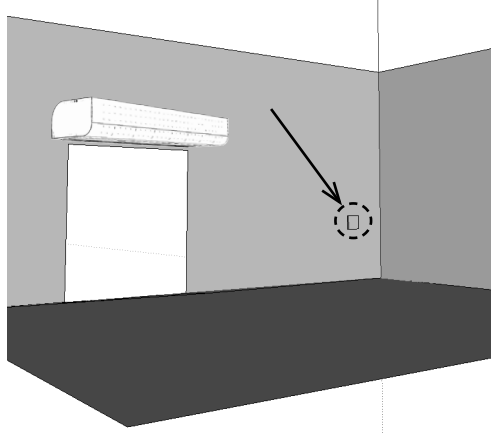

Outdoor temperature - the sensor is included

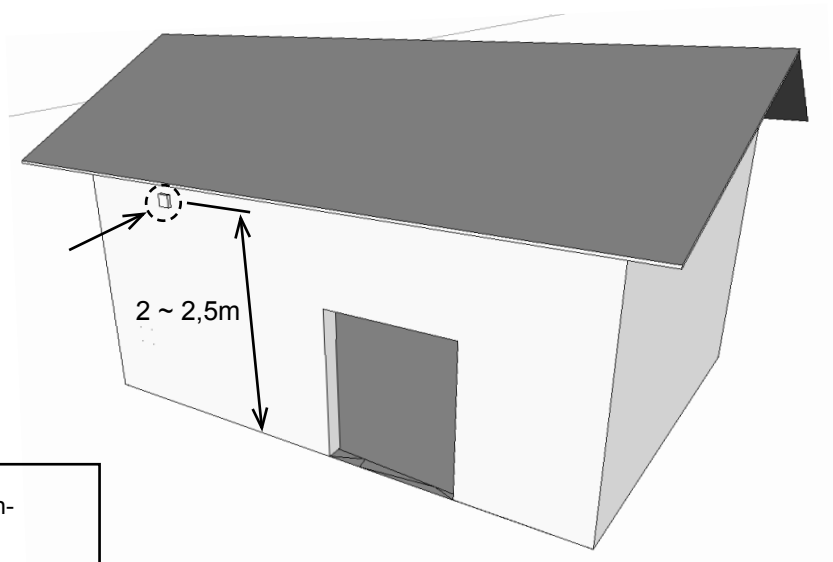

	<p>The outdoor temperature sensor is recommended to be installed on the north side of the building, protected from direct sunlight or other undesirable thermal radiation.</p> <p>The temperature sensor is recommended to be installed in a cover box that should contain a small hole for better results.</p>
--	---

## 2. EXTERNAL ACCESSORIES

### 2.1 CONNECTING EXTERNAL ACCESSORIES



#### PLEASE NOTE

- The unit must be disconnected from the power supply to connect accessories.
- All external control components must be connected according to the wiring diagram.

#### 2.1-1 DS door contact



#### TECHNICAL INFORMATION

- suitable for all SM regulation
- Isolated switching contact with maximum voltage 230V, 6A
- IP67, can be connected as a break or switching contact



#### CAUTION!

Not included with the product.

#### 2.1-2 DK-1 / DK-B3 door contact



#### TECHNICAL INFORMATION

- Isolated switching contact with maximum voltage 12V.
- Cable - Two-core cable with a cross section of 0,5 mm<sup>2</sup>. - Maximum length: 50 m



#### ATTENTION!

Not included with the product.

#### 2.1-3 Thermostatic valve – TV1/1



#### TECHNICAL INFORMATION

- Thermostatic valve to regulate the water exchanger
- Suitable for all types of curtain with water exchanger
- Works independent to the electronic controls



#### CAUTION!

Not included with the product.

#### 2.1-4 Zone valve ZV3 / RT-3-xx



#### TECHNICAL INFORMATION

- Zone valve to regulate the water exchanger
- Cable - Three-core cable with a cross-section of 1.5 mm<sup>2</sup>, 230 V/ 50 Hz.

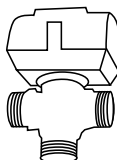

#### CAUTION!

Not included with the product.

## 2. EXTERNAL ACCESSORIES

### 2.1-5 Room thermostat - TER-P

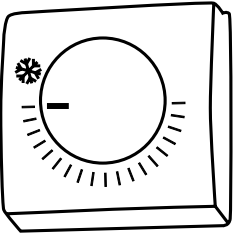

#### **TECHNICAL INFORMATION**

- Room thermostat to regulate heating
- Cable - Two-core cable with a cross-section of 0.5 mm<sup>2</sup>, 230 V/ 50 Hz.

 **ATTENTION!**

**Not included with the product.**

## 3. COMMISSIONING



#### **PLEASE NOTE**

Before starting up the unit, check the following:

- Did you leave inside tools or objects that could damage the unit?
- Is the supply of energy and heating water (if applicable) adequate?
- Is the unit well closed?
- Is the control module properly connected?
- Does the unit have adequate protection according to the applicable standards?

# 4. CONTROL

## READ CAREFULLY!

### Before the initial commissioning, check:

- that the device is well fastened to the support structure,
- that the device is properly closed
- that the power supply is properly connected, including the earthing and the external trigger protection,
- that all the electrical components are securely connected,
- that the installation complies with all the instructions herein,
- that no tool or any other object that may damage the unit remains within.

## ATTENTION!

- Interventions or changes to the internal connections are forbidden and shall result in the loss of warranty.
- We recommend the use of accessories supplied by our company. Contact your supplier in case of doubts regarding the use of non-original accessories.

## START-UP

After connecting power supply, the display lights up and the data is loaded. The device is ready to be activated once the service data has fully loaded.

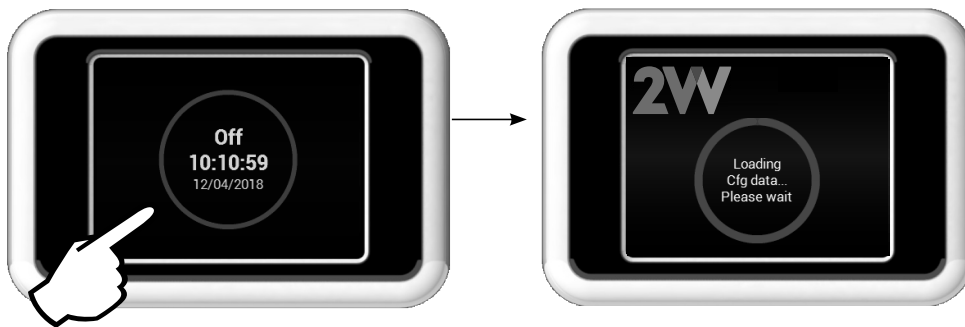

The remote control has a touch screen. The device is controlled tapping the symbols on the screen

## Description of main screen

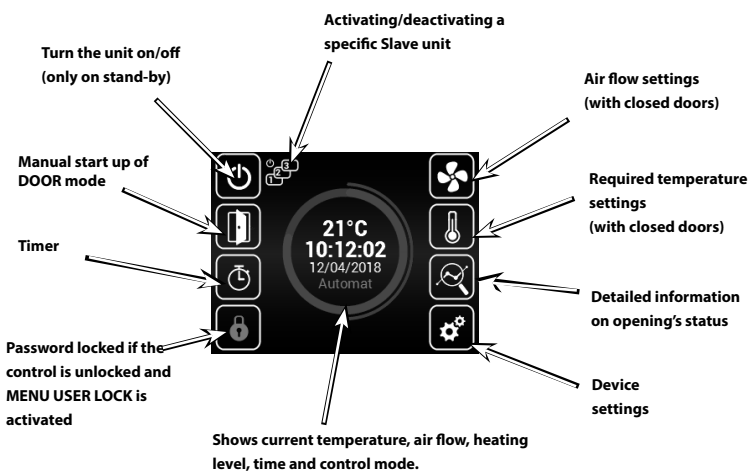

## The menus are described below

- page 13
- page 14
- page 17

## Warning icons

They inform about errors. Clicking on them opens a screen with the error report.

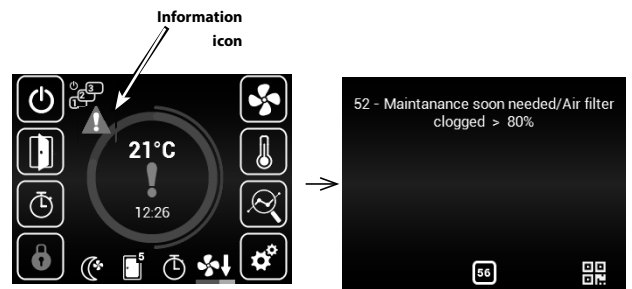

## Information icons

They only inform about status, not errors.

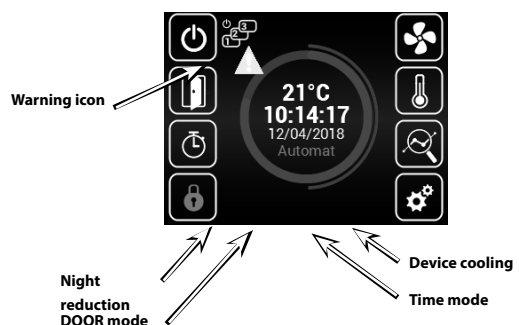

## 4. CONTROL



### Current status

This screen displays detailed status of the shutter and sensor values:

- Current set air flow (step or %), informational icons
- Air temperature for intake\*, exhaust\*, room temperature\*, and temperature outside the building\* (\* - in the event that the necessary sensors are installed and enabled)
- Set heater power (if included)

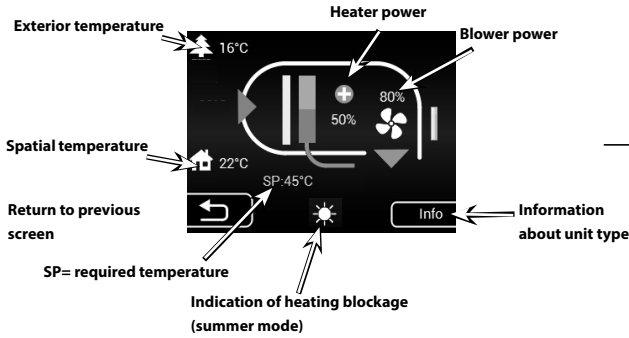

If there are SLAVE shutters connected, the information from them is displayed here. Access to them is available by shifting the screen upward.

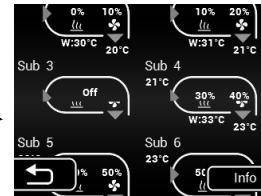
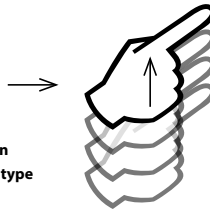

Settings can be found in these instructions in the "SUBUNITS" menu.



### Settings MENU

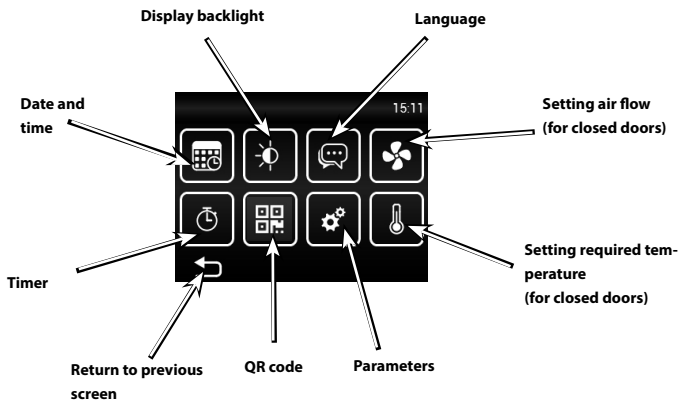

### Required temperature settings with closed doors

Required temperature on selected temperature sensor in 1616/Temperature sensor (ROOM, ROOM BMS)



In the event that heating is suspended by summer mode (MENU - SUMMER HEATING), the "Sun" icon is displayed here without the option to select power.



### Air flow settings with closed doors

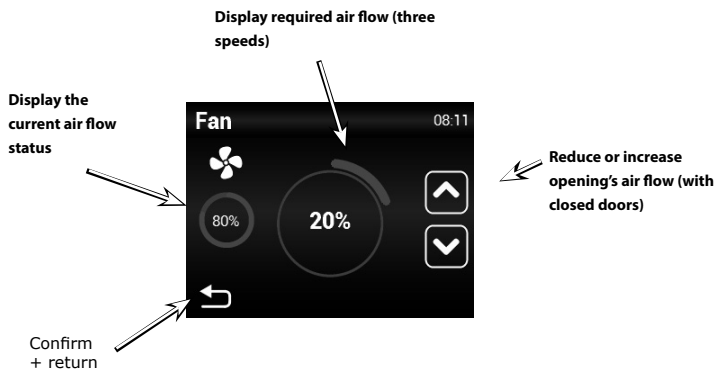

## 4. CONTROL



### Required temperature settings with closed doors

In menu 34 Adv. Fan settings you can select if you want the fan to continue when the set point is reached or if you want the fan to stop. (Default)

When selecting this function the fan will stop when the set point for room temperature is reached. When its not selected the fan will always run.

Setting the time when the curtain will operate after the door is closed. Even when the set room temperature is reached

Annotations for menu 34:

- Minimum fan output for closed and open doors.
- Maximum fan performance for closed and open doors.

To activate this function, you need to select the room thermostat sensor in menu 09.

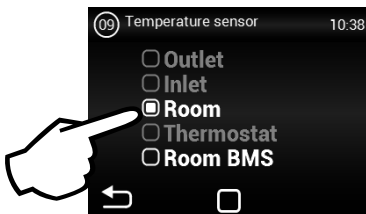

If this is not activated, the curtain will turn off immediately after the door is closed, but the desired temperature must be reached.

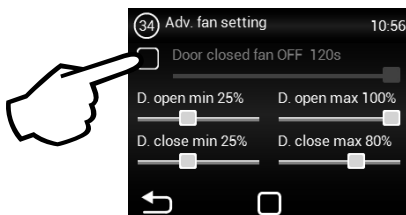

### Date and time settings

Setting current date and time

Annotations for Time&Date menu:

- Confirm + return
- Return to main screen

# 4. CONTROL



## Timer

Unless otherwise set, the unit goes on stand-by mode after the timer expires.

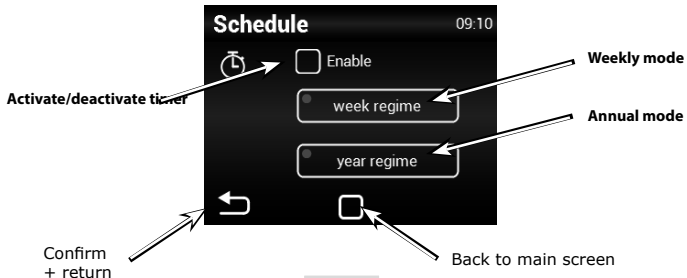

## Weekly mode

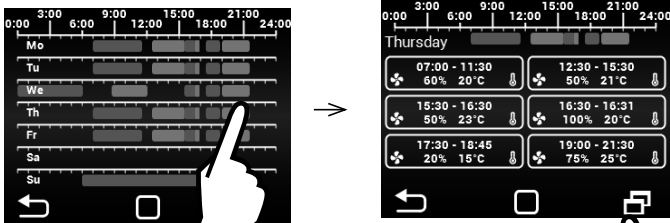

Tap on a day to set different time modes

Button to copy the day plan to another day

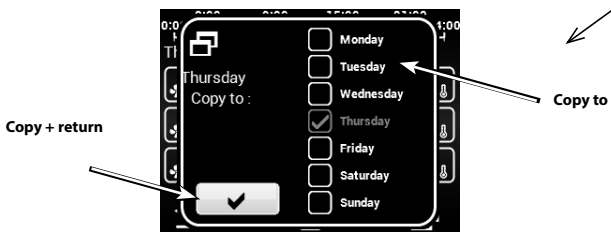

## Annual mode

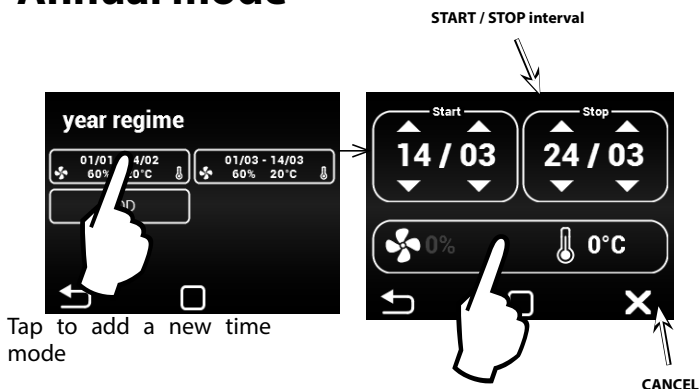

Tap to add a new time mode

CANCEL

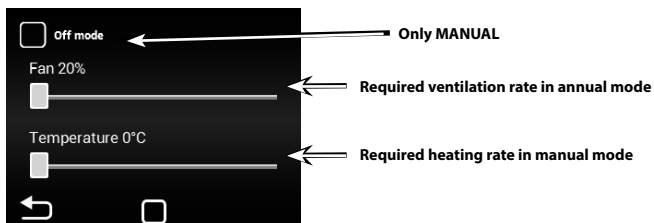

## Language

There are 5 languages available

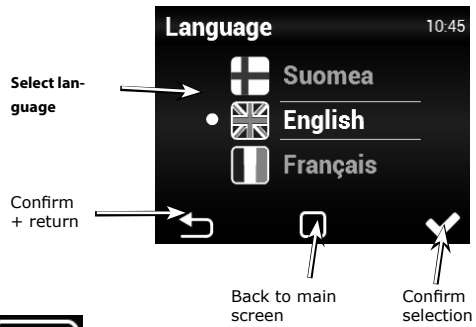

## Lightning settings

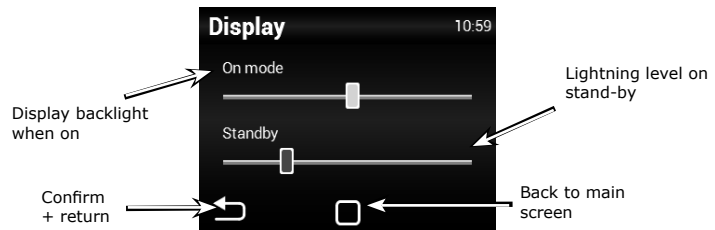

# 4. CONTROL



## Service menu

Enter code 1616 to access the service menu

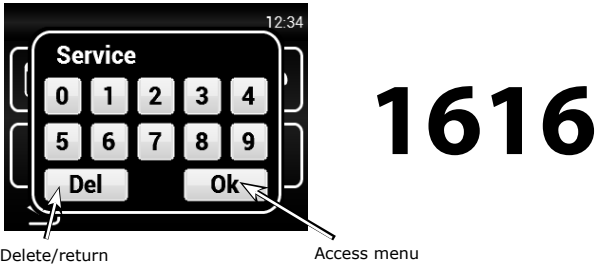

Delete/return

Access menu

# 1616

Choose this menu after centring the screen and tapping on enter

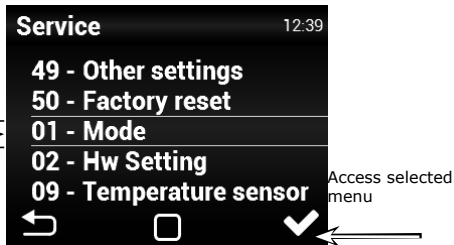

Access selected menu

## MENU - MODE

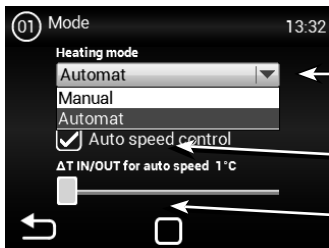

Select heating mode MANUAL / AUTOMATIC

Activate / deactivate automatic speed control.

Setting the difference between outdoor and indoor temperature.

Setting AUTO or MANUAL may block/unblock certain items in the service menu.

**Manual:** works according to the set heating / ventilation output

**Automat:** Heats automatically and trying to reach the desired temperature on the selected sensor (ROOM,BMS) the fan works according to the set performance. if it is not selected (Auto speed control)

**Auto speed control:** automatically regulates the fan's power on the basis of the difference temperature

## MENU - HW SETTING

Use this menu to set the detailed behaviour of the inputs and outputs of the regulators

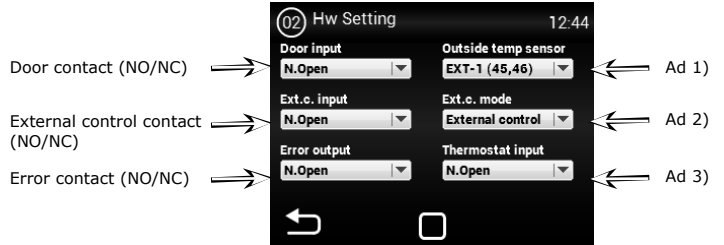

**Ad 1)** - External temperature sensor activation/settings

- None** - no sensor is connected - inactive
- EXT-1 (45,46)** - sensor connected (must be on terminals 45 and 46)
- BMS** - temperature sensor active and used from the parent system

**Ad 2)** - Sets the external contact input behaviour. Options:

- None** - inactive
- External control** - External switching of device
- Night reduction** - Activation/deactivation of the night attenuation (settings described later in this manual)

**Ad 3)** - Thermostat (NO/NC)

## MENU - FILTER TIMER

Use this menu to set the period (in motor hours) after which you will be reminded to replace the filters or reset to timer.



Set the time after which a notice will appear in the main screen.

1000h ~ 5000h

Current timer status

RESET button (use after replacing filters)

Shows the status of the clogged filter in the main screen

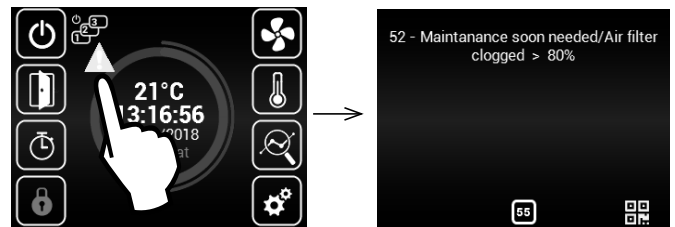

## 4. CONTROL

### MENU - TEMPERATURE SENSOR

**Available only in automatic mode**  
Use this menu to select the sensor to be used for primary temperature control

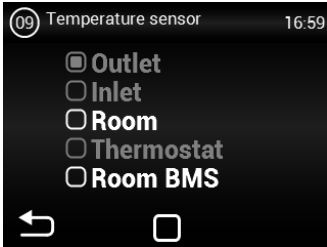

Options:  
**None**  
**Room** – Room temperature sensor  
**Room BMS** – Room temperature sensor from master system

**Available only in manual mode.**

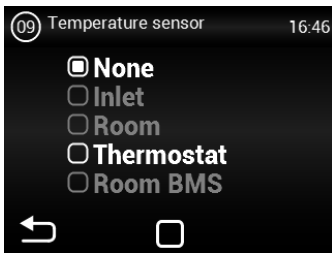

### MENU - MODBUS RTU

Use this menu to set the Modbus RTU communication parameters



**!** An incorrect setting may prevent communication with the regulator

### MENU - USER LOCK

Use this menu to set the limits to control the regulator with a multi-level panel

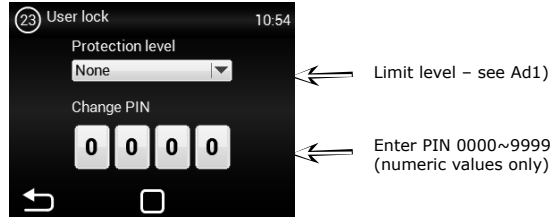

Options:  
**None** – Limit inactive  
**On/Off** – Only On/Off and access to the information menu are enabled in the main screen  
**On/Off, Temp, Flow** – On/Off, the information menu, and temperature and air flow settings can be accessed without password.  
**Full** – Only the information menu can be accessed without password  
**User mode** – Special user mode, see image below



### MENU - SUMMER HEATING

Use this menu to set heating limits in summer months  
Winter mode set by default. Enabling the function allows heating also in summer

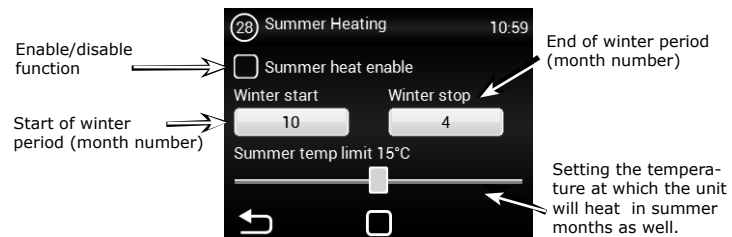

### MENU - Night Reduction

This MENU allows for setting reduced temperatures during night hours with closed doors.

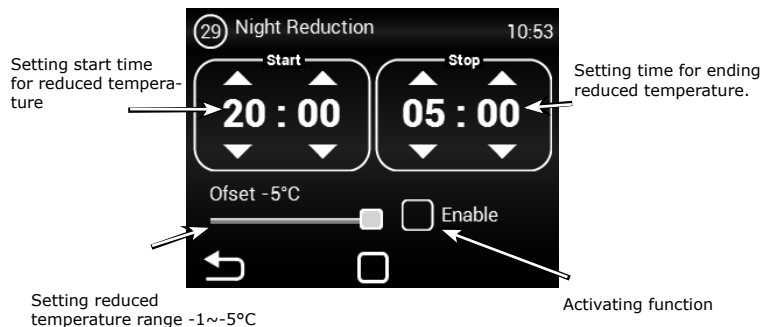

In this menu, the reduction of temperature may be set only by five degrees at the set time compared to the set (required) temperature.

# 4. CONTROL

## MENU - DOOR CONTACT

This MENU allows for setting the behaviour of the regulator according to doors contact

Activation/de-activation of this function

Mode: **Fixed** - fixed setting  
**Selflearning** - automation menu

Setting Fixed mode

Blower power with open doors

Required temperature with open doors

**Suspend mode:** at a set time, or upon achieving a specific temperature

Time of shutter operation per minimum rotation of the motor from closed doors.

Time of shutter operation per maximum rotation of the motor from closed doors.

Blower power with open doors.

The temperature the shutter attempts to reach with open doors.

Room  
Outlet  
Inlet  
Room  
Thermostat  
Room BMS

In this menu it is possible to specify which sensor will be active and the temperature the shutter will attempt to reach after closing doors so as to balance temperature loss. After reaching the set temperature, the shutter transitions into the selected automatic/manual mode.

## MENU Selflearning

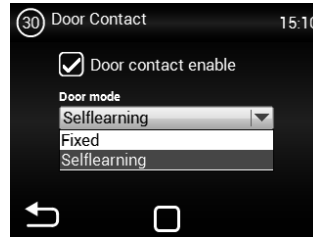

**Selflearning**- available only in automation and active function mode (Auto speed control), depending on the number of open doors it optimises the period in which the shutter is in operation, even when doors are closed.

Must be set to activate **Selflearning**.



## MENU - WATER ANTIFREEZE

The menu is enabled only in units with water exchanger

Settings (20%-100%)

Ventilation rate with open doors (20%-100%)

## 4. CONTROL

### MENU - SUBUNITS

Use this menu to set the behaviour of the IC-S regulators connected as SLAVE

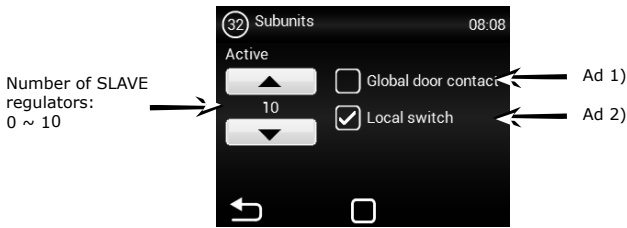

Number of SLAVE regulators: 0 ~ 10

Slave address parameter:

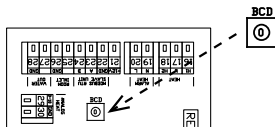

ADDRESS	SLAVE UNIT	ADDRESS	SLAVE UNIT
1	1	6	6
2	2	7	7
3	3	8	8
4	4	9	9
5	5	A	10

**Ad 1)** - Use one door contact as main. Its status will be sent to the SLAVE regulators and it will no longer be necessary to connect it to each regulator, if required.

- Not allowed = the door contact will not transmit to the SLAVE regulator from the MASTER
- Allowed = the door contact will transmit to the SLAVE regulator from the MASTER

**Ad 2)** - Activates in the main screen the icon to turn each SLAVE regulator ON/OFF. If inactive, all the SLAVE regulators will be turned on or off simultaneously

- Not allowed = The SLAVE regulators are turned on/off simultaneously
- Allowed = The SLAVE regulators can be turned on/off individually from the main screen

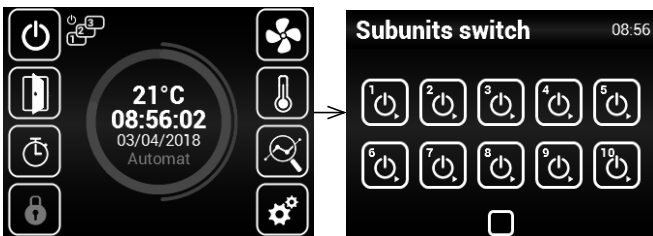

### MENU - Adv. WATER SETTING

This MENU is available only for units with water heat exchanger. It allows for advanced setting of water heat exchanger regulation.

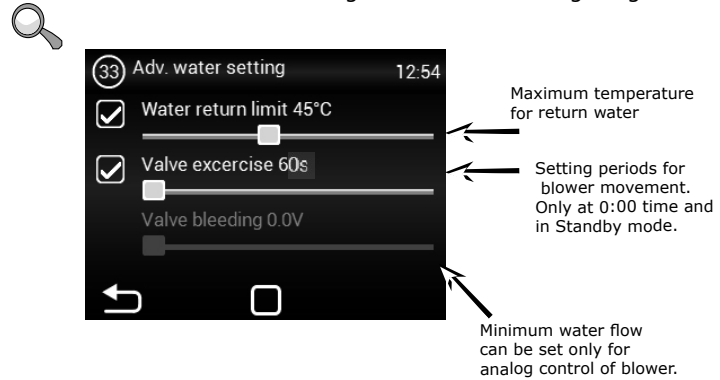

### MENU - Adv. fan setting

The MENU for setting the blowers when closing and opening doors. It allows for advanced settings of blower control.

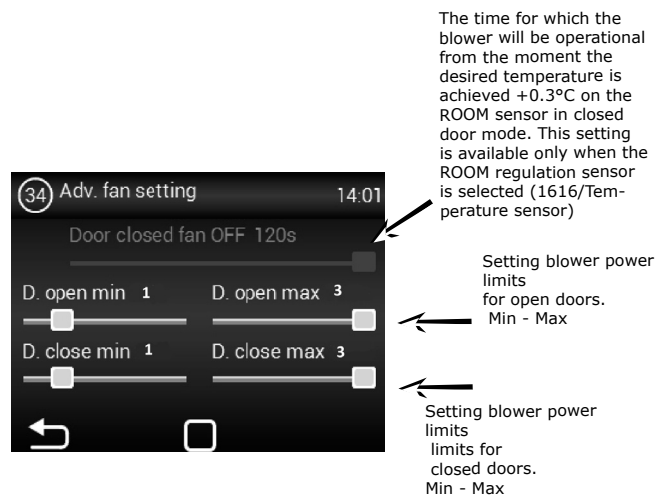

The set limits on blower power restrict the extent of blower control for open and closed doors. This restriction is applied to manual and automatic control of blower power. Exceeding limits in any blower power setting is signalled when the setting element turns red with the text overruns.

# 4. CONTROL

## MENU - OTHER SETTINGS

Use this menu to set the remaining parameters

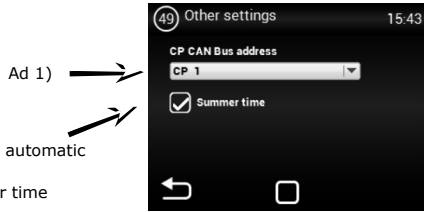

Enable/disable automatic switch of summer/winter time

**Ad 1)** - Sets the CAN address of the control panel so up to 2 control panels may be connected to the MASTER regulator  
 Options: CP 1 = control panel's address is 1  
 CP 2 = control panel's address is 2

**! ATTENTION!**

Each panel must have its own address, otherwise it may result in the malfunction of the regulator.

Terminals must be set if multiple panels are to be connected. They are found in the main electronics and the controller:

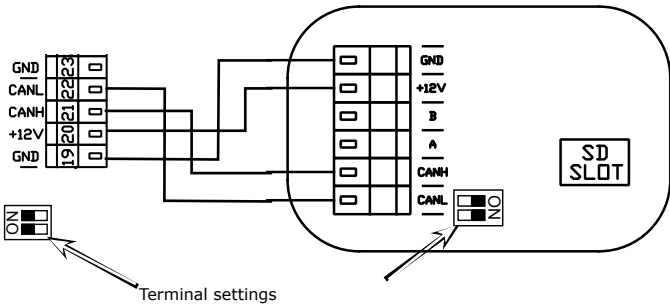

Example of controller connection - Option 1:

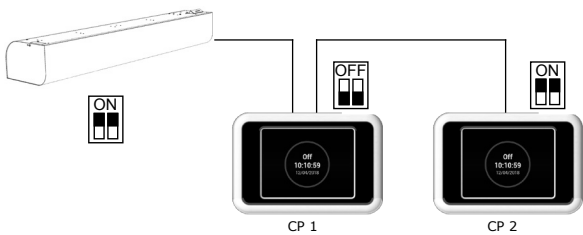

Electric connection - Option 1:

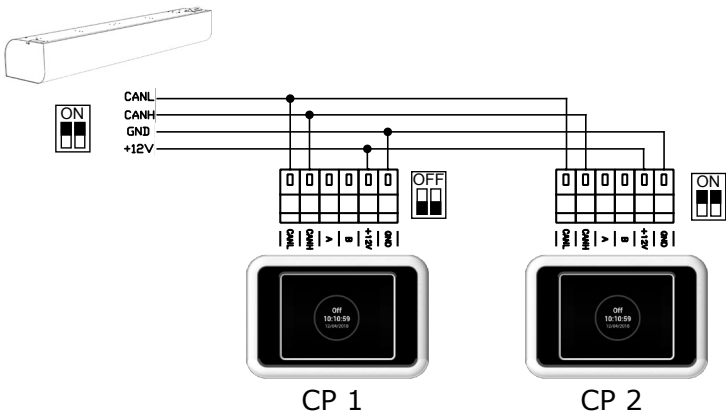

Electric connection - Option 2:

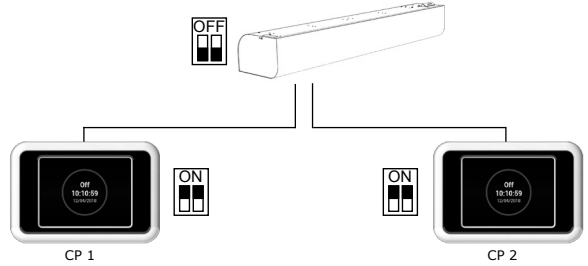

Electric connection - Option 2:

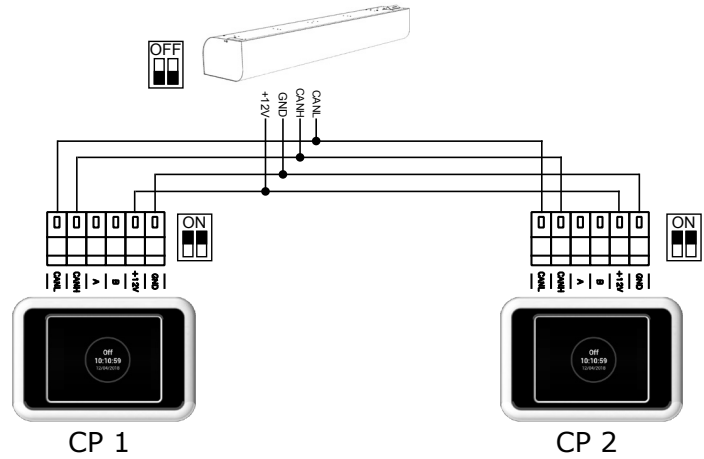

## MENU - FACTORY RESET

Use this to reset the default values

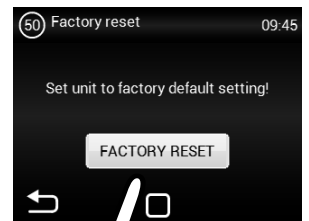

Press "FACTORY RESET" to reset the default values of MENU 1616



Once completed, we recommend to turn the main supply off and on.

## 5. MALFUNCTIONS

### 5.1 MALFUNCTIONS

**Disconnect the main power supply before any intervention to the unit. If you are not sure of the correct steps, do not attempt to perform any repairs and call a professional service!**

Description	Unit behaviour	Likely problem	Solution
44 – Fan error	Unit out of order	Overheated fan or defect on thermal contact of inlet fan	Determine the cause of the overheating (defective bearing, short-circuit...) or replace the motor.
45 – Mandatory maintenance/filter clogged	Unit operational	Filter clogged or the time to replace it has come	Replace filters. After replacing, do not forget to reset the MENU 1616 – FILTER TIMER
46 – Heater malfunction	Unit out of order	Heater malfunction	Check the heater and the condition of the safety thermostat Does the heater have proper cooling? Check engine running.
65 – Communication error	Unit out of order	Communication error	Check the communication cable for damages and if it is properly connected Observe the wiring diagram to prevent occurrences that may disrupt communication (wiring near high tension, phenomena on site causing disruptions)
<b>Unit's not working</b>	Unit out of order	Power supply interrupted	Check that the power supply is not interrupted
		Cracked fuse	Check the fuse in side the control module
<b>The heating switches off automatically</b>	Unit operational but not heating	The heater overheats	The heater overheats due to insufficient air flow. Check that the ventilators are in good order and that the air supply is not disrupted.

#### **ATTENTION!**

Switch off the main power supply before any intervention inside the unit. Let the unit cool!

## 6. MAINTENANCE

### 6.1 CLEANING



- Do not use compressed air, chemicals, solvents or water to clean the unit.
- Use a soft brush or a vacuum cleaner to clean the suction cover and the inside of the unit.
- See the installation manual of the ESSENSE NEO curtain

## 7. SERVICE

### 7.1 IF YOU ARE UNABLE TO REPAIR THE UNIT

If you were unable to solve a problem, contact the supplier or the representative of 2VV. Warranty and post-warranty service are provided by the supplier or an authorised service included in the list available at the supplier's.

Give the following information to the supplier or service:

- **type designation of the air curtain**
- **accessories in use**
- **place of installation**
- **serial number**
- **conditions of the installation (incl. electrical)**
- **period of operation**
- **detailed description of the malfunction**

### 7.2 – DECOMMISSIONING THE PRODUCT – LIQUIDATOIN

Before scrapping the product, make it unusable. Old products still have raw materials that can be reused. Take them to a collection centre for secondary raw materials. It is preferable to have the product liquidated by a specialist so that the recyclable materials may be reused. Take the unusable parts to an appropriate waste disposal site.



The liquidation of materials must observe the applicable waste management regulations.

# 8. WIRING DIAGRAM

## RGJ3-VCES2-CO-S-MA

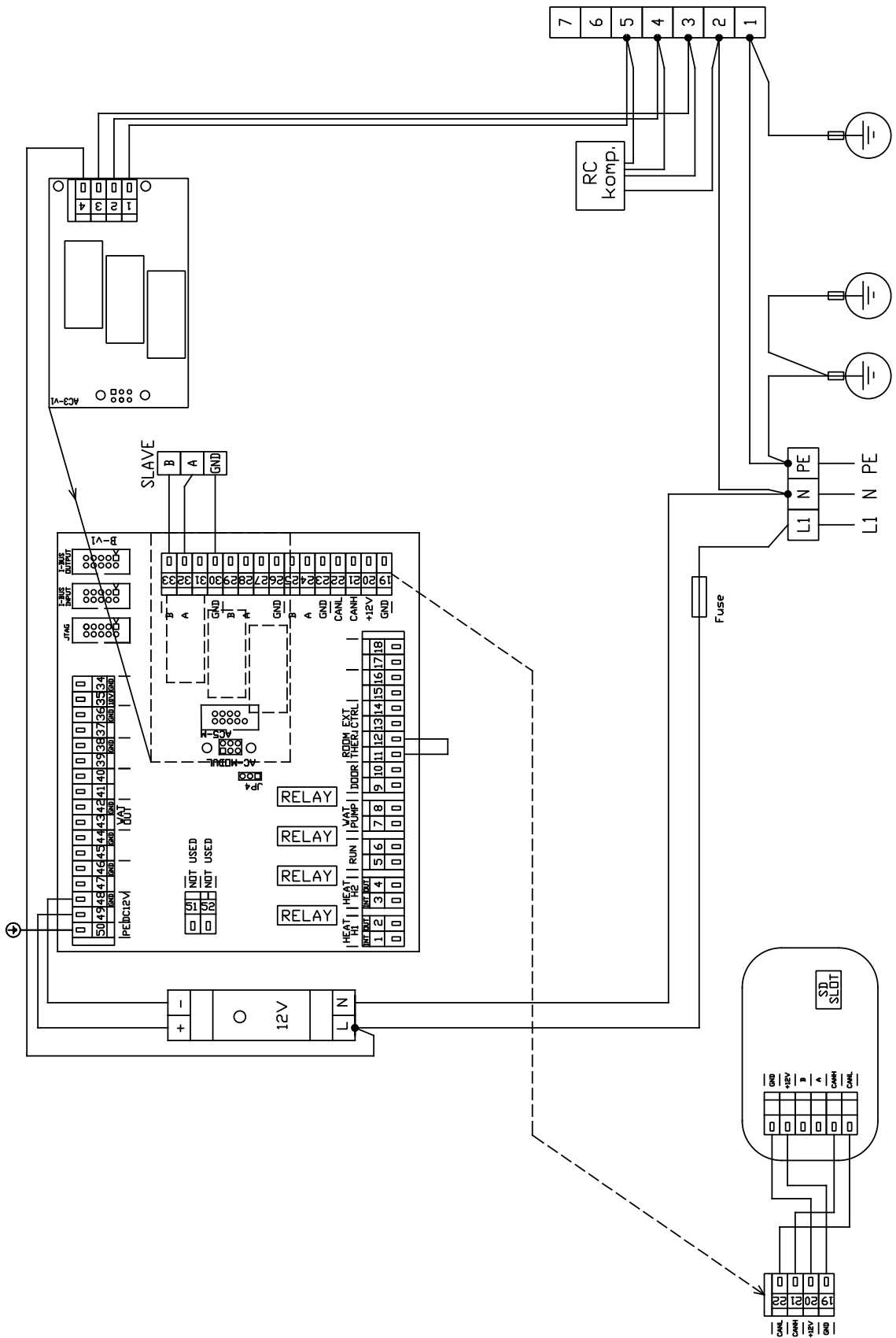

# 8. WIRING DIAGRAM

## RGJ3-VCES2-CO-E-MA

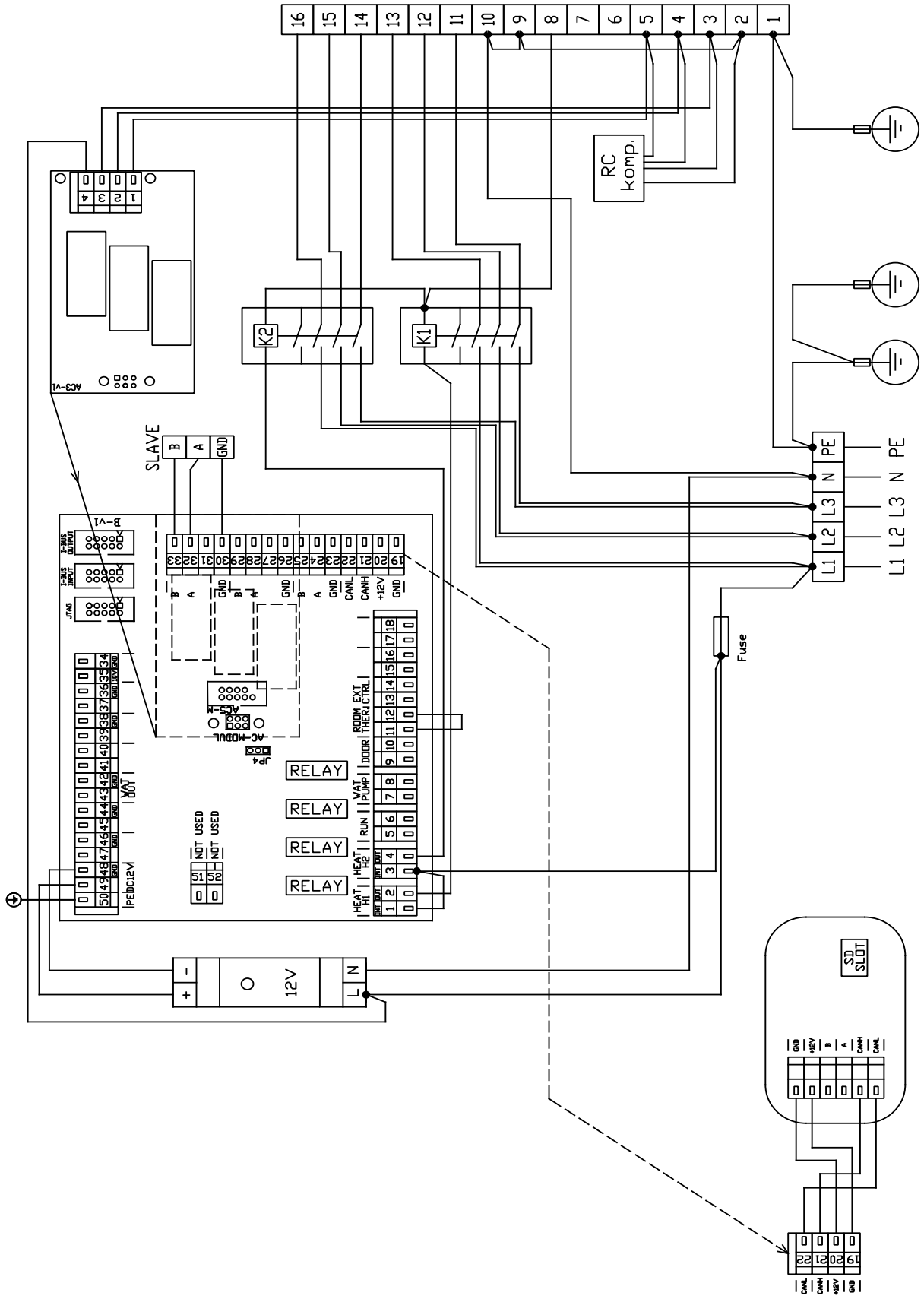

# 8. WIRING DIAGRAM

## RGJ3-VCES2-CO-V-MA

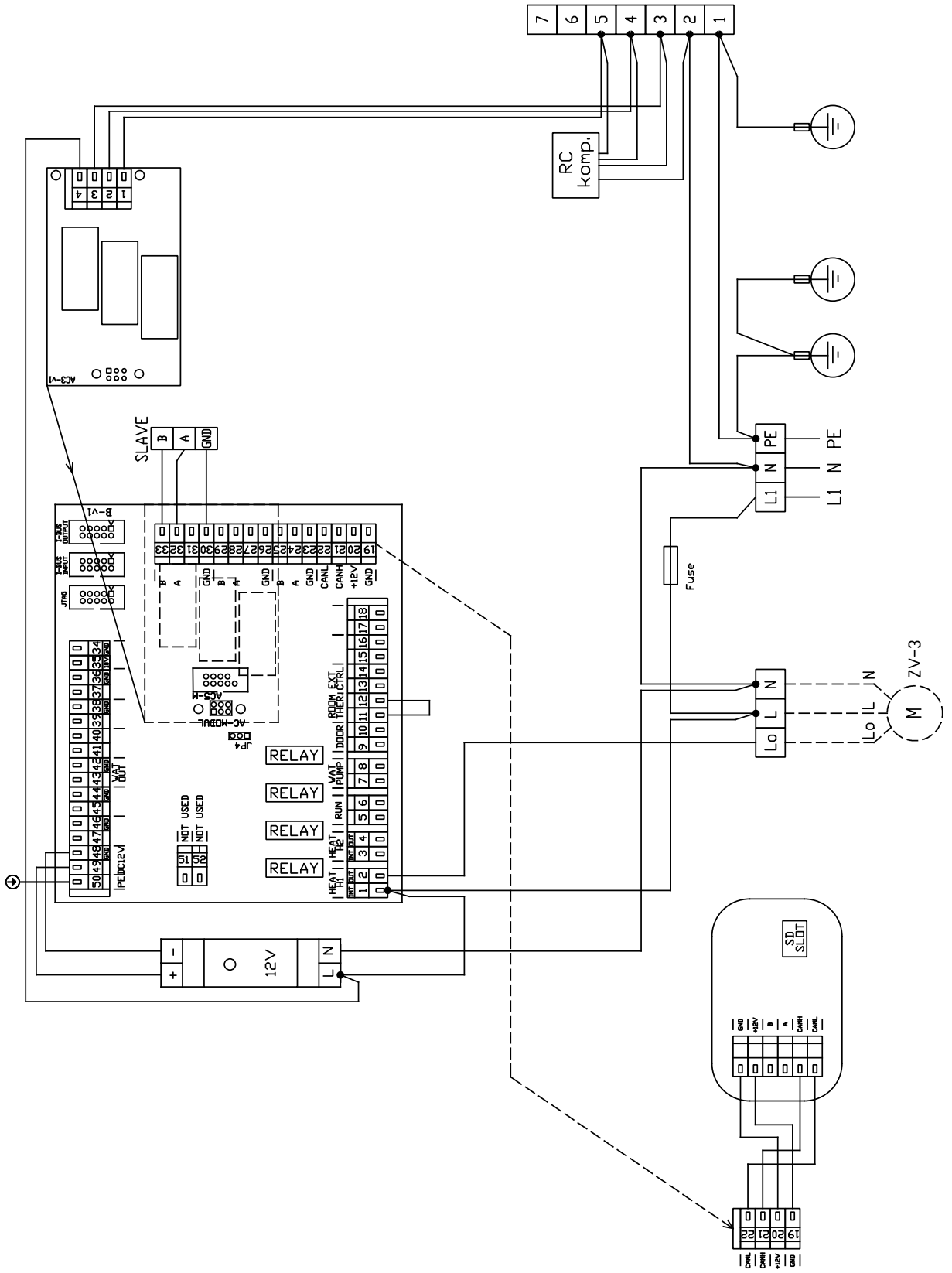



8. WIRING DIAGRAM

RGJ3-VCES2-CO-E-SL

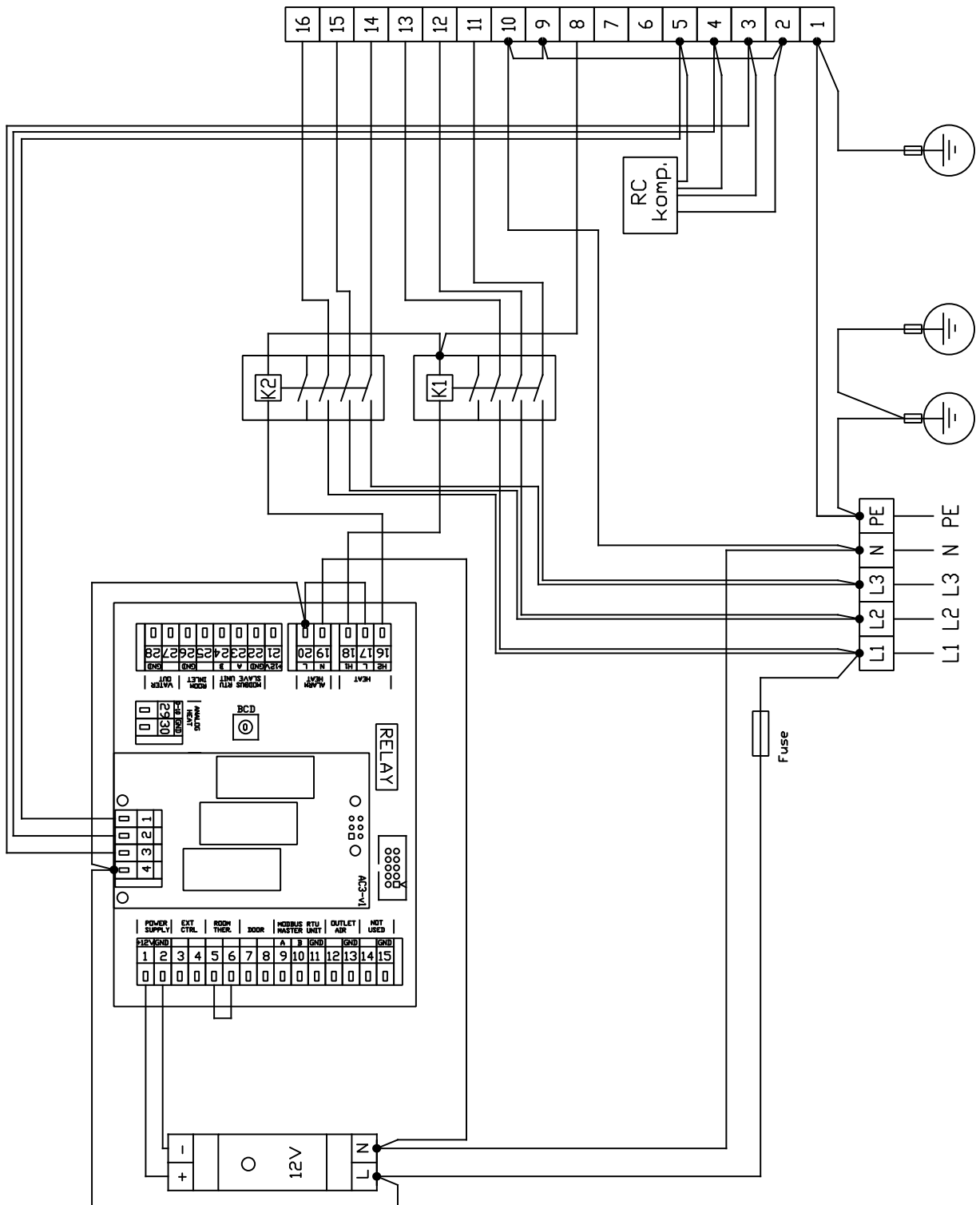

# 8. WIRING DIAGRAM

## RGJ3-VCES2-CO-V-SL

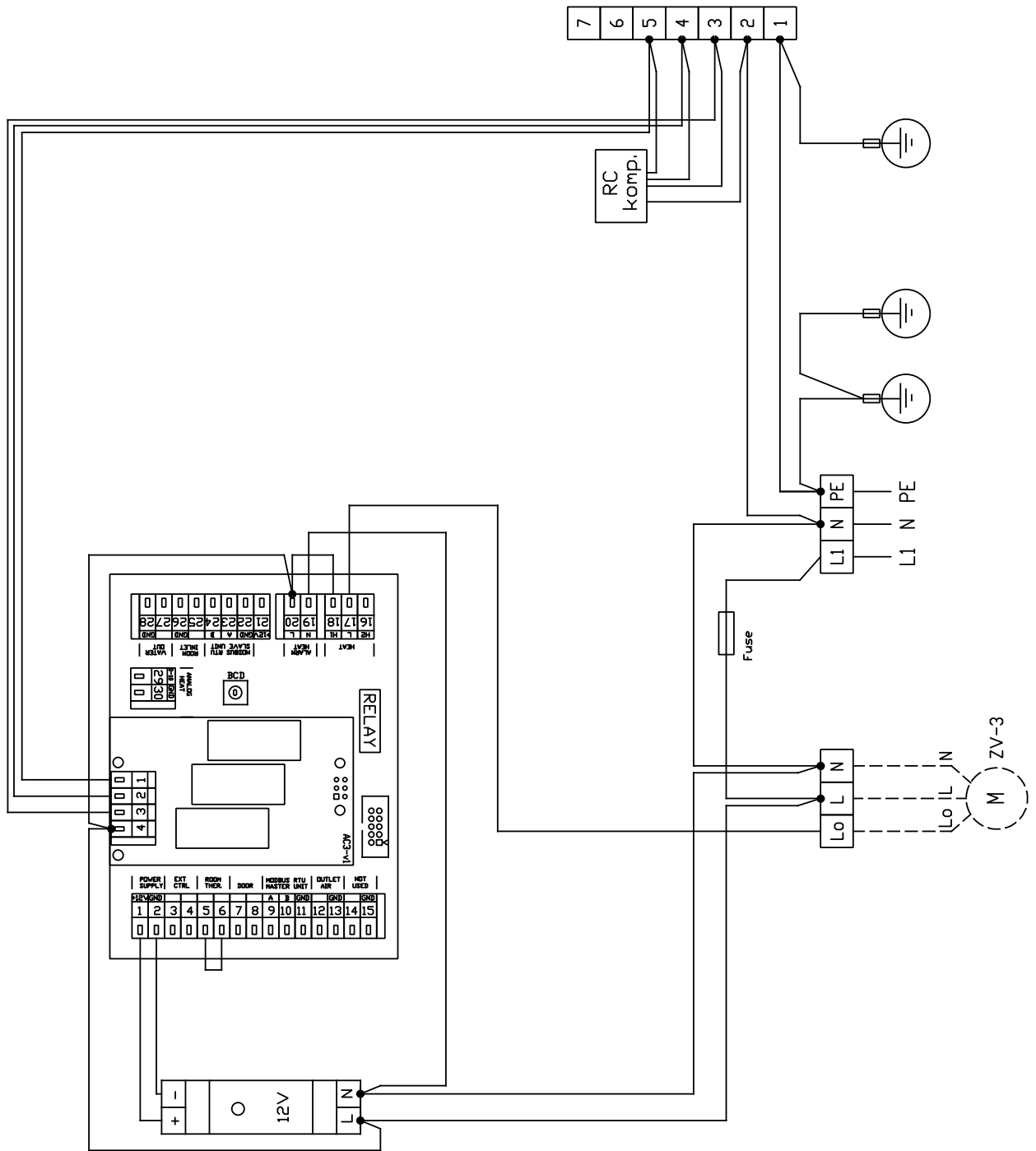

## 9. CONCLUSION

### **9. CONCLUSION**

In case of any doubt or query, do not hesitate to contact our sales or technical support departments.

### **CONTACT**

**Address:**

2VV, s.r.o.,  
Fáblovka 568,  
533 52 Pardubice,  
Czech Republic

**Internet :**

**<http://www.2vv.cz/>**

